

Handy Oscillographic Recorder
OR100E/OR300E
 (standard model) (harmonic analysis model)



- Compact, lightweight and slim. Notebook size (B5) 4-channel isolated recorder
 - Fax/modem capability using a PC card
 - Powerful trigger functions
 - Four-mode power supply for field use
- Standard external interfaces for flash ATA memory card and RS-232 communication
 - Harmonic analysis and real-time RMS measurement functions (OR300E only)

Additional functions

- Temperature measurement using thermocouple
- Data recorder function enabling extended-duration measurement

The Complete Multi-purpose Recorder Series!

Introducing the OR100E / OR300E..

(standard model)

(harmonic analysis model)

The OR100E/OR300E series of Handy Oscillographic Recorders are complete multi-purpose recorders featuring up to four isolated analog input channels, fax/modem capability using a PC card, four-mode power supply and powerful trigger functions. The OR300E also has a harmonic analysis function. These recorders

are small in size, with a footprint equivalent to a sheet of B5 paper, and weigh only 1.4 kg.* They can be used standalone for a wide range of applications, from low-speed/long-term continuous recording to high-speed recording of transient conditions.

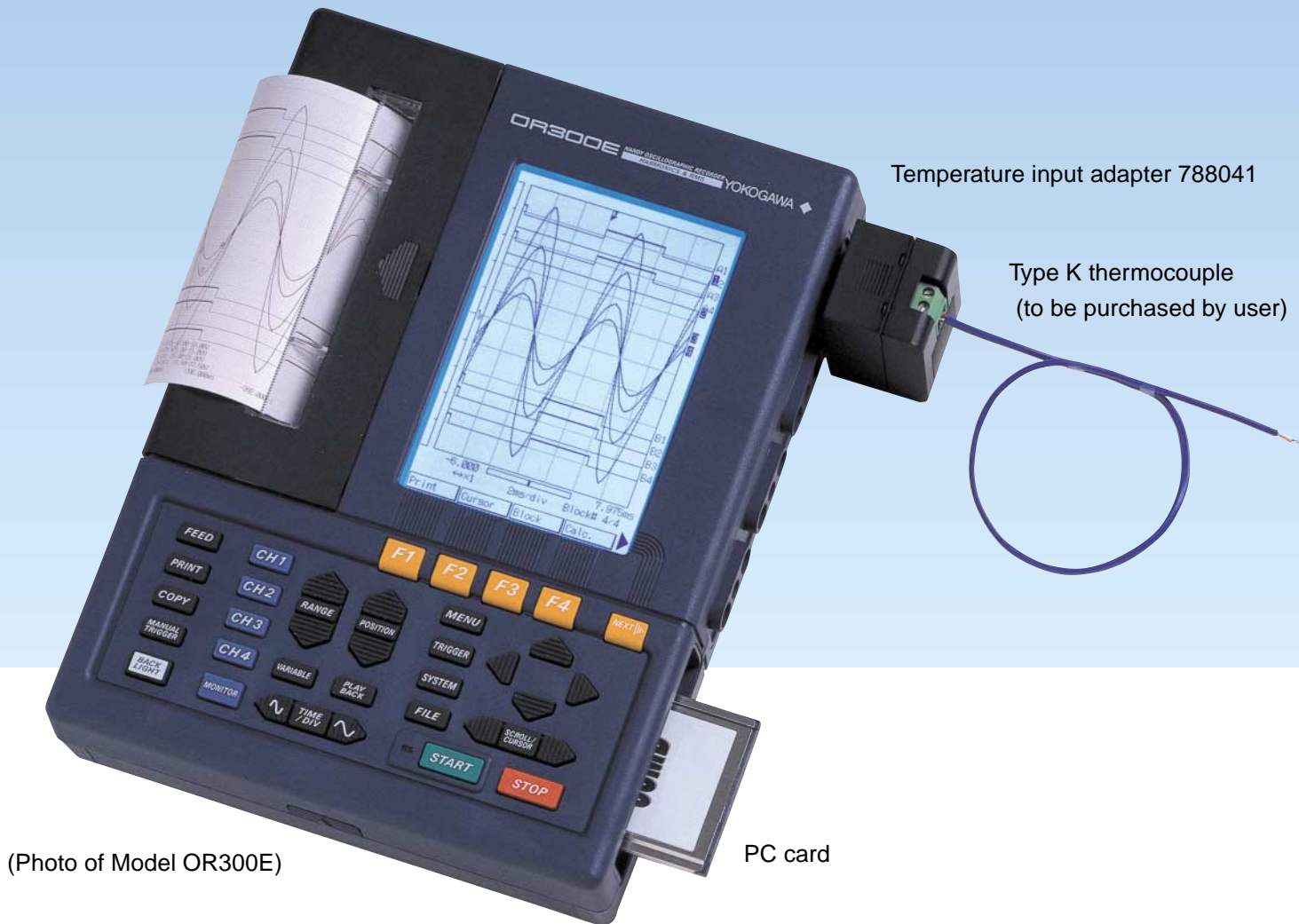

(Photo of Model OR300E)

Four-channel 500 Vrms direct input in a slim, light body



The notebook-size OR100E/OR300E Series weighs only 1.4 kg* but can take simultaneous measurements on up to four isolated analog channels. The analog input unit can directly measure voltages as high as 500 Vrms operating at high speed and high resolution (400 kS/s, 11 bits). The OR100E/OR300E Series supports logic measurements on as many as eight channels using optional logic probes, enabling twelve simultaneous analog and logic measurements at high speed.

* OR100E 4-channel model; not including battery weight

Comparison of OR100E and OR300E

	OR100E	OR300E
Basic concept	2-channel and 4-channel basic models	2-channel and 4-channel models with harmonic analysis function
Input types	DC or Off	DC, RMS or Off
Measurement modes	Real-Time Recording, Memory, Real-Time + Memory	Real-Time Recording, Memory, Real-Time + Memory, Harmonic Analysis
Input performance	400 kS/s, effective 11-bit A/D, max 500 Vrms input, temperature input (with type K thermocouple and temperature input adapter connected)	
Memory length	128K data per channel	
External dimensions (mm)	Approximately 190(W) x 46(H) x 256 (D)	
Weight (4-channel model without batteries)	Approximately 1.4 kg	Approximately 1.5 kg

The quality of the power supply?

Wave window trigger

The wave window trigger enables real-time monitoring of problems that are difficult to pick up with conventional triggers, such as instantaneous power failure, sagging, and impulses on utility power supplies (50 or 60 Hz).

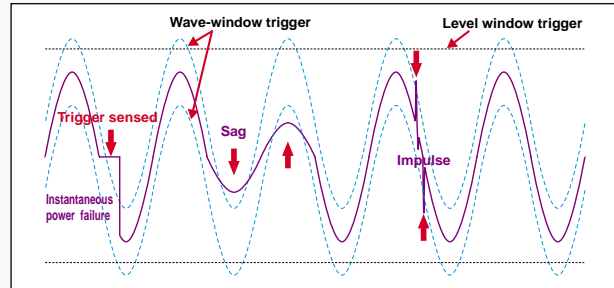

Want to monitor data remotely?

Fax modem function

With the OR100E/OR300E you can set up a wide-area data collection network over telephone lines using commercially available fax/modem PC cards. This eliminates constraints on the physical distance between the oscillographic recorder and the monitoring station.

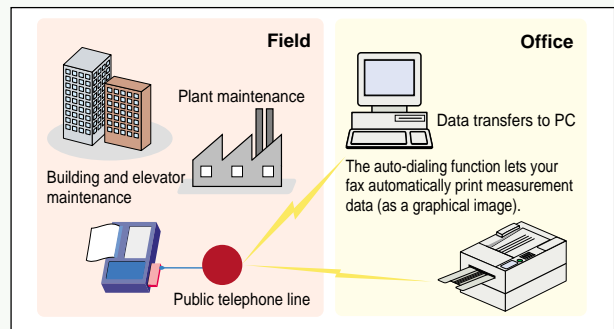

Temperature Measurement

In addition to the direct measurement capability (up to 500 Vrms), the new OR100E/OR300E includes a temperature input adapter (788041-1) that works with type K thermocouples. The adapter is powered by the OR100E/OR300E, so there's no need for a special power supply when you use the recorder in the field or take long-duration measurements. The OR100E/OR300E has a special temperature input adapter range (see the diagram on the right) for easy setup.

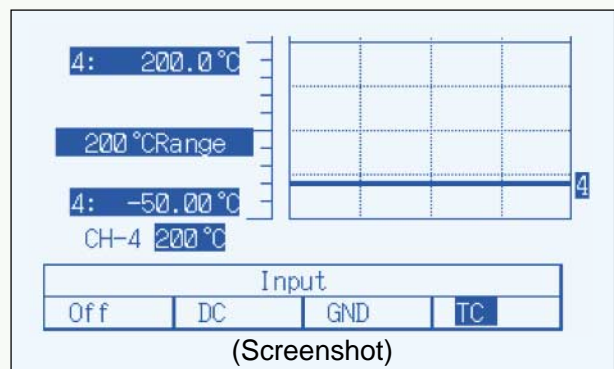

Data Recorder Functions using a PC card

The OR100E/OR300E lets you write measurements continuously and in real time to an ATA flash memory card (PCMCIA card). This means internal memory capacity is no longer a limitation on total recording time*¹, allowing you to take long-duration measurements previously handled by data recorders. You can also display measured data stored in flash memory on the OR100E/OR300E display for easy field checks.*² In addition, ACRAWin32 is available to assist you in making reports when handling massive amounts of data.

Standard data memory time

Measurement cycle	Time/div (Hz) example	For 20 MB PC card		For 160 MB PC card	
		1 s/div (80 Hz)	50 msec/div (1.6 kHz)	1 s/div (80 Hz)	50 msec/div (1.6 kHz)
Measurement time	4 analog channels and 8 logic channels	Approximately 170 minutes (2.8 hours)	Approximately 8 minutes	Approximately 1380 minutes (23 hours)	Approximately 65 minutes (1 hour)
	4 analog channels	Approximately 515 minutes (8.5 hours)	Approximately 25 minutes	Approximately 4100 minutes (68 hours)	Approximately 200 minutes (3.3 hours)

*¹ : Maximum sampling rate: 1.6 kS/sec; *² : Displays 128 kdata/ch steps

Four-mode power supply for field use

In addition to working with a 3.5-hour* rechargeable battery (788021), the OR100E/OR300E also can be powered by an AC adapter (100–240 V), DC adapters (12 V/24 V/48 V), and alkaline batteries. Choose the power supply type that best fits your needs.



* In trigger standby mode

Powerful Triggers, Memory and Display/Recording

Full support for all of the functions needed in a waveform observation recorder –useful in the field and in the lab.

Powerful Trigger Functions

The OR100E/OR300E Series provides powerful trigger functions for reliable measurement of monitored parameters. In Normal Trigger Mode, triggers are set for the rise and fall levels. Wave-window Trigger Mode allows you to monitor for power supply waveform abnormalities in real time. In addition, pre-trigger settings may be set as desired.

Normal Trigger Mode

Normal Trigger Mode can be used to set triggers such as time triggers, logic triggers and independent triggers for each of up to four analog channels. A wide variety of trigger types can be used, including rise and fall triggers, bi-slope trig-

gers, level (high/low) triggers, and window IN/OUT triggers. You can also set trigger sensing to sense fluctuations in the root mean square value of AC signals, and trigger filters to prevent trigger malfunctions due to noise.

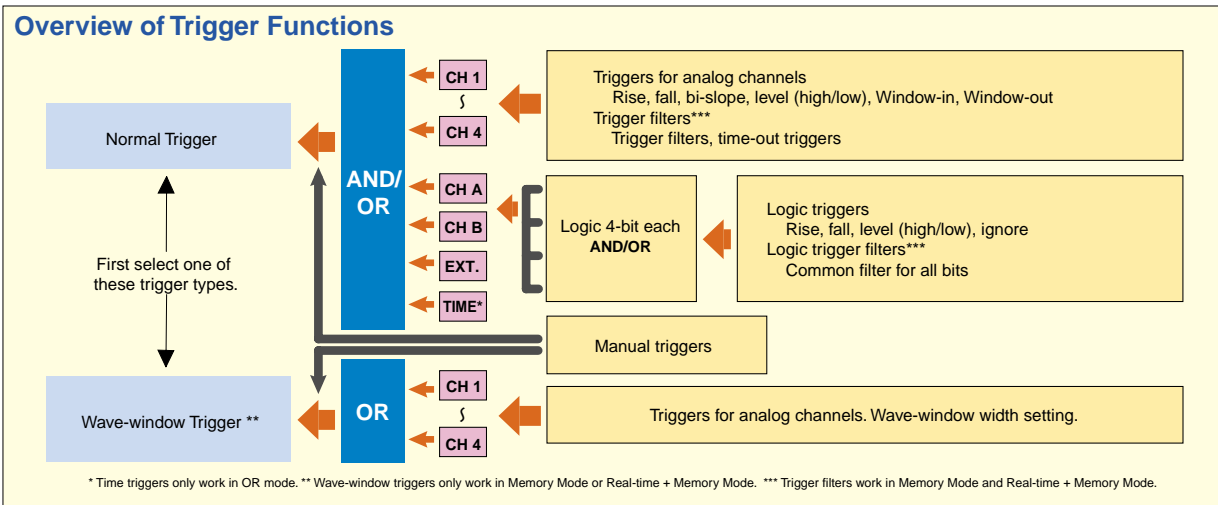

Wave-Window Trigger

The wave-window trigger is used for monitoring 50-Hz and 60-Hz power supply waveforms. A wave-window (area consisting of the base waveform plus a certain width) is created based on an ideal power supply waveform (sine wave) or the actual power supply waveform. The trigger is sensed when the measured signal is outside the wave-window. The wave-window trigger is used for real-time monitoring for phenomena which cannot be detected by conventional level parameters, such as instantaneous power failures, sags and impulses in the commercial power supply. Separate wave-windows can be set for each analog channel.

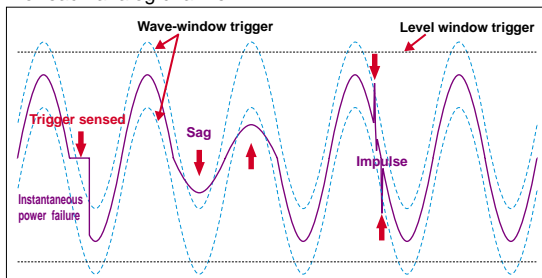

Example of Wave Window Trigger Applications

The OR100E/OR300E Series can be used in real-time monitoring for power supply quality abnormalities when troubleshooting office automation equipment such as copy machines or workstations.

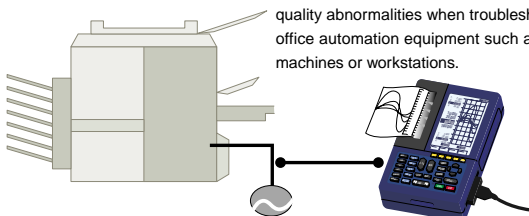

Examples of Trigger Applications

Trigger Filter Function

When a trigger filter is used, a trigger is sensed if the trigger conditions are satisfied and maintained continuously for a preset length of time. Trigger filters can be used to prevent trigger malfunctions due to noise.

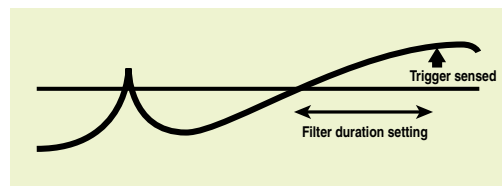

Time-Out Trigger Function

When the time-out trigger function is used, a trigger is sensed only if the trigger conditions are initially satisfied but not satisfied again within a preset length of time. Time-out triggers are useful for monitoring for periodic waveform level fluctuations.

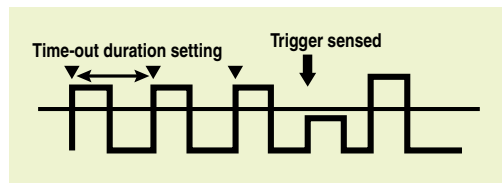

Time Trigger Function

When the time trigger function is used, a trigger is sensed at a set time or during a set time interval.

Functions in a Compact Body

Use the OR100E/OR300E Series when adjusting or starting up power generators and motor drives.



Sharp Display, Calculation Functions and High-Quality Recording Functions

Measurements are clearly displayed on a 5.7-inch backlit LCD display. You can view captured data and print out just the areas you need. Other capabilities include real-time recording, X-Y display and recording, and transient measurement (memory sampling when a trigger is sensed during real-time recording).

Display

A half-VGA display is used for 50% better resolution than in Yokogawa's older models.

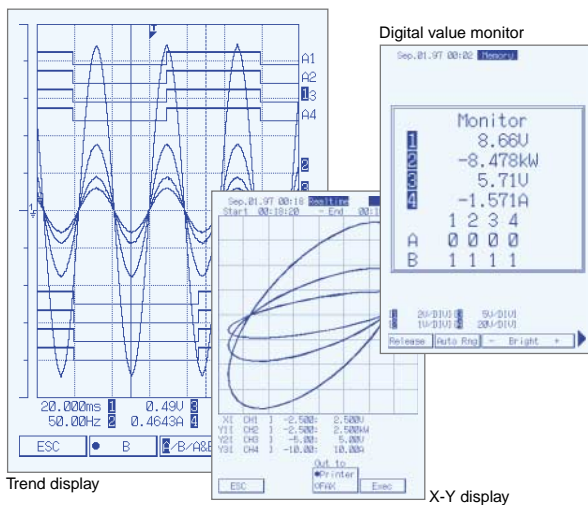

Standard Calculation Functions

In addition to scaling, the OR100E/OR300E Series supports statistical calculation functions for determining maximum, minimum, average, root mean square and surface area values for ranges specified with the cursor.

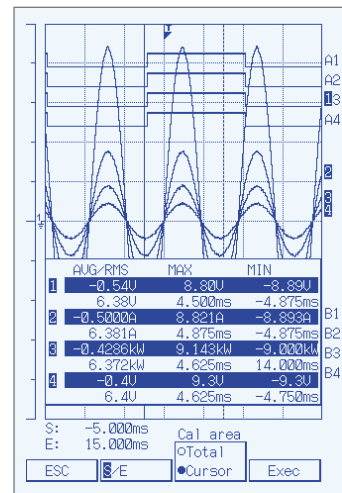

High-quality recording onto chart with effective width of 100 mm and length of 10 meters

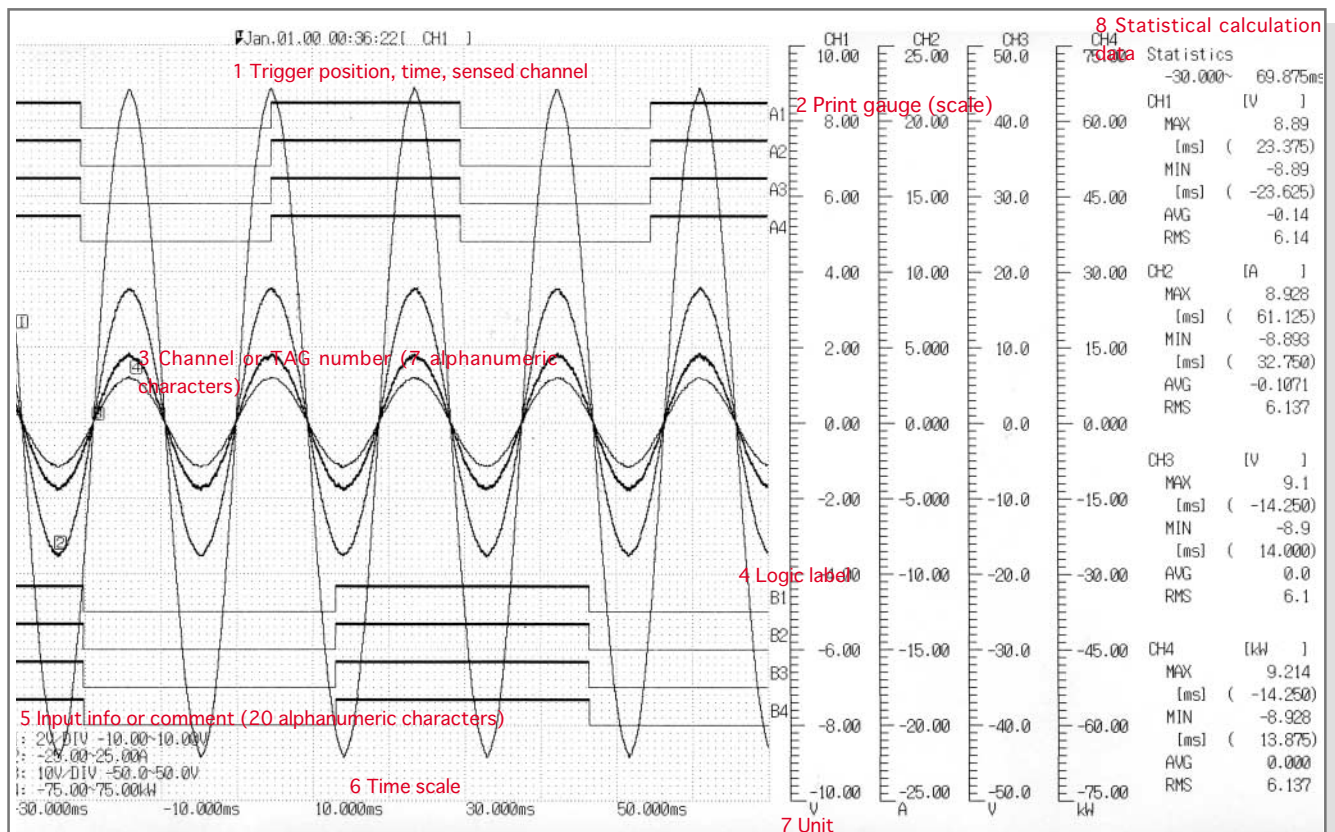

Significantly Improved Measurement Efficiency

The OR100E/OR300E Series has fax/modem capability for remote data collection. Data can be saved on a flash ATA memory card.

The OR100E/OR300E Series provides standard support for Type II PCMCIA cards. You can use a commercially available fax/modem card or flash ATA memory card for remote data collection or to save data electronically. These handheld recorders open up new application fields for mobile measurement terminals.

■ Fax/Modem Capability Using a PC Card

The OR100E/OR300E Series makes it easy to collect data remotely using a phone line and a commercially available fax/modem card. Simply connect the PC card to a phone line to connect to your recorder remotely, eliminating the distance factor.

- The auto-dialing function can be used to automatically transfer captured data to your fax for high-quality output (as a graphical image). This reduces the need for periodic visits to the measurement site and allows you to respond quicker if a problem is detected.
- If you call your recorder over a phone line from a PC, you can transfer files to the PC or remotely control the recorder (e.g., change recorder measurement ranges or trigger levels) through the PC.

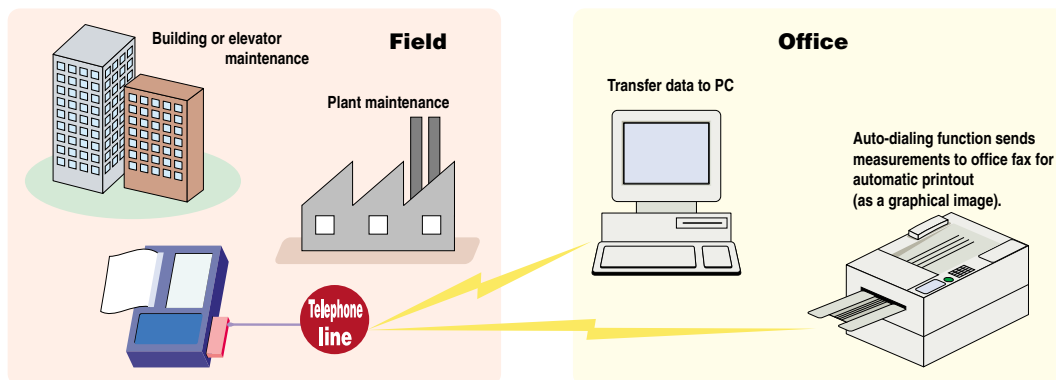

■ Saving Data to a Flash ATA Memory Card

Measurements can be saved in binary or ASCII format to flash ATA memory cards with a maximum capacity of 160 MB. You can process or analyze measurement data using the ACRAWin32 data viewer, or commercially available spreadsheet software. Screen data from your OR100E/OR300E recorder can be saved in bitmap (BMP) format as graphical objects. Saved bitmap files can be pasted into documents in Windows programs such as word processors to easily create reports. Moreover, both measuring data which is saved in binary format and setting data stored in ASCII format can be redisplayed or re-recorded by OR100E/OR300E recorders.

Creating a Report (Example)

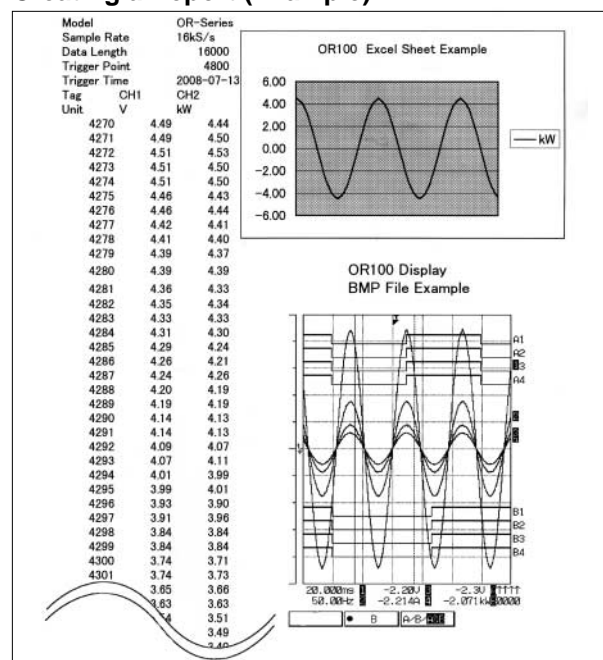

Creating a Report with a Flash ATA Memory Card (Using MS-Excel)

with PC Card Function

Use the OR100E/OR300E Series for maintenance and periodic inspection on elevators and air conditioning systems



● Auto-Dialing Function for Dialing a Preset Fax Number

The auto-dialing function can be used to automatically transfer measurements to your fax for high-quality output (as a graphical image). Captured data (recorded data) over set time periods can also be periodically sent to your fax if the auto-dialing function is combined with the time trigger function.



● Calling your recorder over a phone line from a PC (standard support for ACRAWin32 data viewer)

If you call your recorder over a phone line from a PC, you can transfer files to the PC or remotely control the recorder (e.g., change recorder measurement ranges, sampling periods, memory length, trigger modes/levels) through the PC. (This can also be done through the RS-232 interface.)



ACRAWin32 Data Viewer Software

Use a PC for more efficient use of OR100E/OR300E measurements.

The ACRAWin32 data viewer software allows you to quickly view OR100E/OR300E measurements on a PC. It has a wide range of user-friendly functions based on Windows, including zooming, scrolling, cursor-range calculations, and file conversions.

Viewer Function*

The viewer quickly redraws OR100E/OR300E measurements on your PC screen. Both analog and digital drawing options are available. You can also enlarge or reduce the waveform display, scroll through the display, perform cursor-range calculations, and convert files. Measurements can be loaded via a flash ATA memory card or a communication line (RS-232 interface or modem line) using OR connector software.

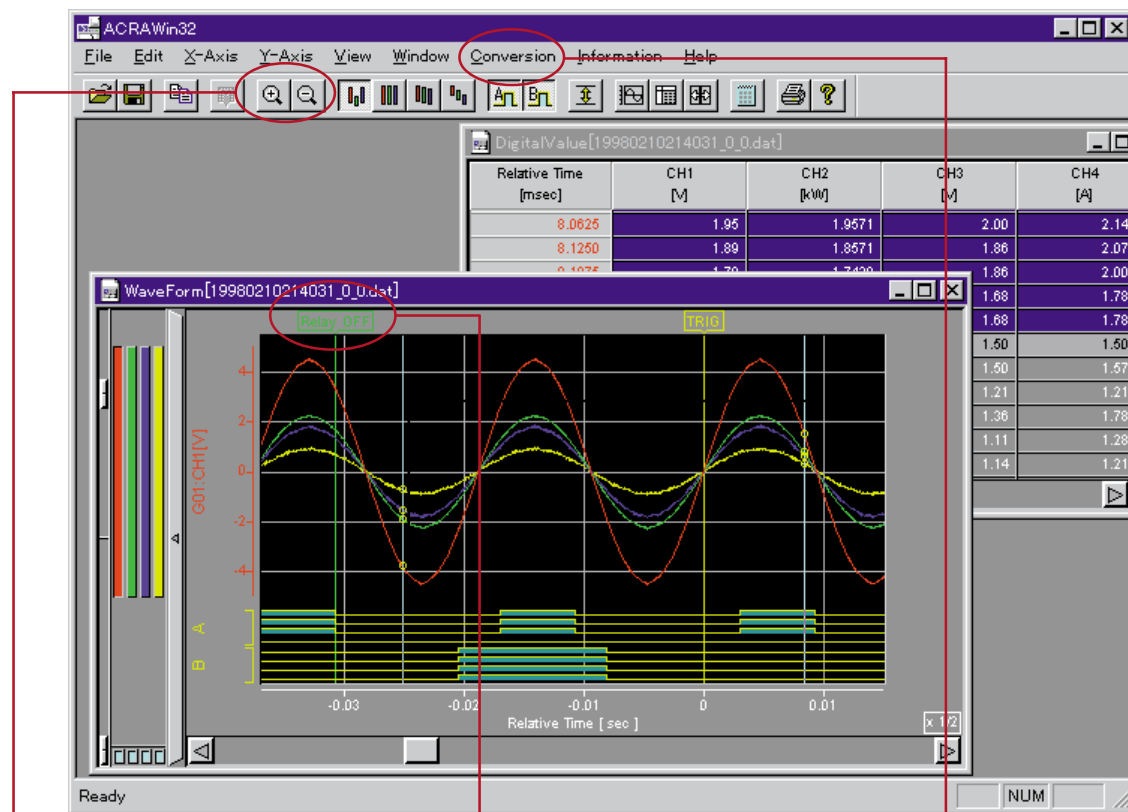

Zoom-in/Zoom-out Button

Simply press these toolbar buttons to quickly lengthen or reduce the time axis on the waveform display. These buttons are useful for checking long-term trends and zooming in on transient phenomena.

Trigger Marks and Mark Display

Trigger points can be displayed, and marks can be displayed at any location on the waveform display for typing in messages.

Data Conversion

Cursor-range data can be converted to ASCII format, Lotus 1-2-3 format, or Excel format for processing and analysis with commercially available spreadsheet software.

Cursor Value Display Window

Data No.	Cursor A	Cursor B	Difference
430	8024		0.00
431	7104		0.00
Time	2888.0710	2888.0713	00.00.00.070
	28.95.24.974	05.50.05.005	00.00.00.070
Relative Time(Start Point) [msec]	074.0750	338.3750	01.5000
Relative Time(Trip Point) [msec]	25.1150	8.3750	01.5000
Tag	Value A	Value B	S-A
001-CH1[M]	-3.77	1.94	5.71
002-CH2[kV]	-3.7571	1.9571	5.7143
003-CH3[M]	-3.79	1.98	5.76
004-CH4[A]	3.0714	1.9000	1.1714

Digital data between the cursor points can be displayed on the screen and copied to the clipboard for pasting to other applications to make reports.

Cursor-range Calculations

Calculate Item	Start	Stop	Min	Max	P-P	Average	RMS
Tag							
CH1	-0.50	0.50	0.00	0.70	0.70	0.24	0.24
CH2	-0.50	0.50	0.0714	0.9286	0.8571	0.2800	0.2800
CH3	-0.50	0.50	0.00	0.70	0.70	0.24	0.24
CH4	-0.50	0.50	0.00	0.2000	0.2000	0.0714	0.0714

This function can be used to determine maximum, minimum, P-P, average and RMS values for the cursor range.

Data Printout

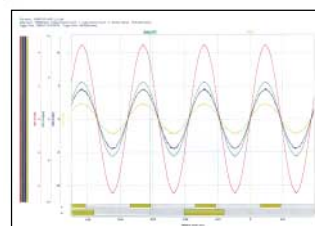

You can select a print area with the cursor in order to print out a waveform or digital values in the desired range.

Use the OR100E/OR300E Series for maintenance or engineering work at plants or on heavy machinery.



■ OR Connector Function*

This function can be used to connect your OR100E/OR300E recorder to a PC through the RS-232 interface or modem line. Once connected, measurement data and settings can be received by the PC, or you can change the settings through the PC and send the changes to the recorder.

● Multiple Destination Registration Capability

With the OR connector function, you can register multiple OR100E/OR300E recorders as destinations on a single PC. Just specify the desired destinations by clicking the check boxes to connect to them in sequence in order to receive data or send settings to the recorders.

Destinations can be selected (specifying the destination telephone number) through the serial port or modem.

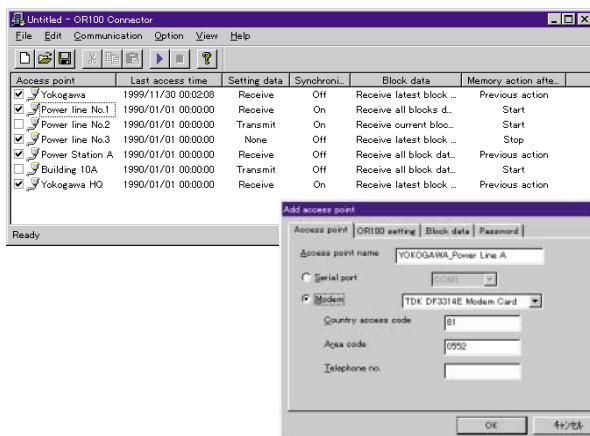

● Setting Modification Capability

You can use your PC to change various settings on a connected OR100E/OR300E recorder, including the measurement ranges, filters, sampling periods, memory length, trigger modes and trigger levels (wave-window triggers and harmonic mode cannot be changed).

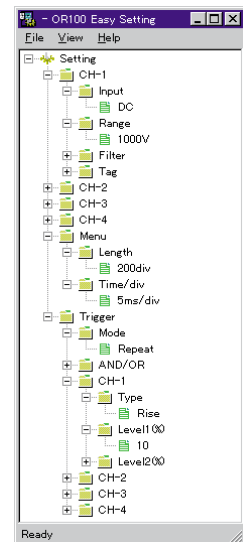

● Data Reception Mode Options

There are a number of data reception mode options for receiving data from a connected OR100E/OR300E recorder. For example, you can receive all data blocks, just the most recent data blocks, or just measurements which have been captured since a specified time. Select the option which is best for the intended application.

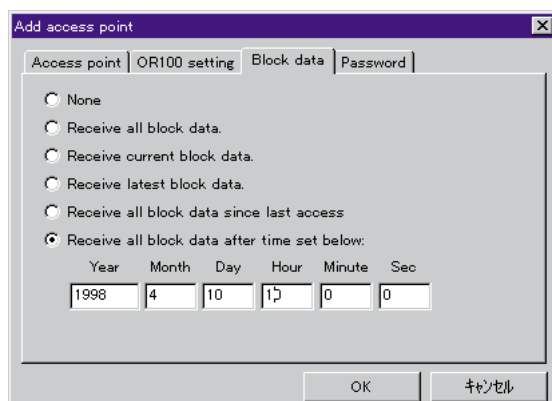

* Some software models also allow the viewer function to be used with the OR1400 and ORM. The connector function is for the OR100E/OR300E only. This software does not support loading or redrawing of OR300E harmonic analysis results.

Harmonic Analysis Function and Real-Time RMS Measurement

Improved functions for monitoring and analyzing power supply and power system quality

The OR300E Series includes all of the functions of the OR100E Series, and also provides improved functions for monitoring and analyzing power supply and power system quality, as well as a harmonic analysis function and real-time RMS (root mean square value) measurement function.

Harmonic Analysis Function

This function measures phenomena such as power supply waveforms containing harmonic components, and the harmonic current flowing into or out of a commercial power system. Measurements are put through harmonic analysis up to the 40th order. Analysis parameters which can be

selected are the root mean square value, content and phase angle of each harmonic order, and active power, power content, and power phase angle. This function also displays the overall root mean square value, overall distortion factor, active/reactive/apparent power, and power factor.

Waveform Observations (Examples)

The captured waveform can be checked.

Harmonic power analysis works only in Automatic Analysis mode.

Bar graph displays of root mean square values and contents of orders up to 40

Display of phase angles of orders up to 40

List display of RMS values, contents, and phase angles, as well as total RMS value and overall distortion factor

Bar graph displays of active power and power contents of orders up to 40

Display of phase angles of orders up to 40. Current flow into or out of the power system can be determined.

List display of active power, power contents, and phase angles, as well as active/reactive/apparent power and power factor

Function(OR300E)



Use the OR100E/OR300E Series for troubleshooting power facilities, distribution boards and heavy machinery.

4-Channel Harmonic Analysis Capability

The OR300E has up to four isolated analog input channels. You can take measurements simultaneously on all channels, or perform harmonic analysis on each of them separately (the display switches between the different channels). A four channel recorder allows you to simultaneously measure three-phase current and simultaneously measure harmonic components superimposed on each layer (voltage output from a clamp probe can be scaled to current values).

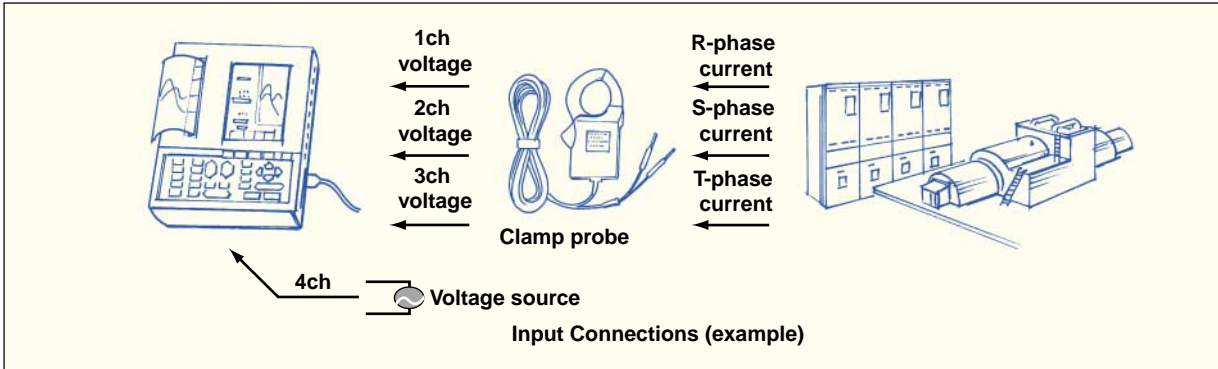

Two Analysis Modes for Different Applications

1 Automatic Analysis Mode

Use this mode to automate the process of repeated measurement, analysis and display (or data saving) for selected calculation parameters. Automatic Analysis mode can also be used for harmonic power analysis.

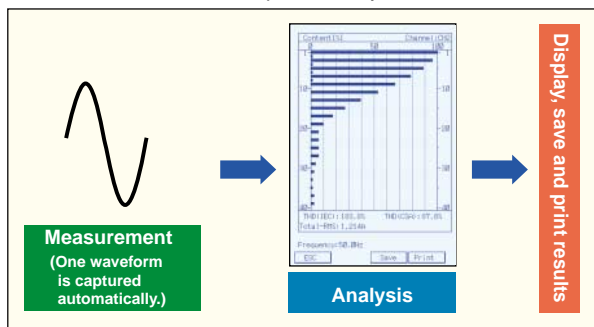

2 Waveform Analysis Mode

Use this mode for harmonic analysis of a waveform captured using the trigger functions. Analysis is performed starting at any specified cursor point. Waveform Analysis Mode can be used to display on one screen waveforms captured over as many as 1000 cycles, and to specify the desired area to be analyzed.

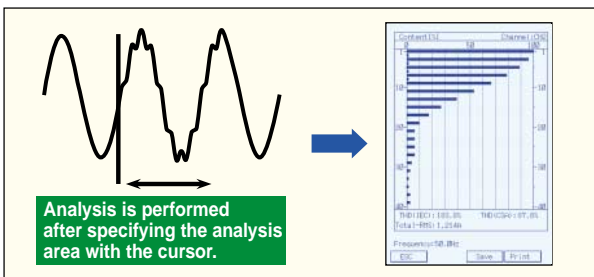

Harmonic Triggers (available in Automatic Analysis mode)

A distortion factor trigger and a content trigger (for the harmonic component superimposed on each order) are provided as harmonic triggers. These triggers can be used as trigger sources when saving or faxing data.

Use Analysis Results on a PC

Harmonic analysis results can be saved to a flash ATA memory card in CSV format for use with commercially available spreadsheet software. Analysis results can also be continuously saved (trend data) to a PC in order to check fluctuations over a fixed period in parameters such as content, distortion factor, and active/reactive/apparent power.

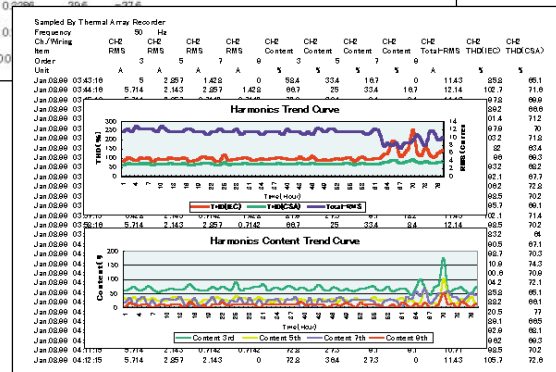
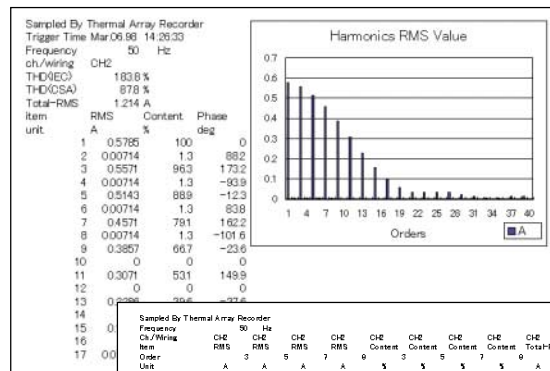

Harmonic Analysis Result Trend Saving Capacity (approximate)

Data for approximately 40 days can be continuously saved when the following parameters are saved as trends over a one-minute period to a 10-MB PC card: RMS values, contents and phase angles of orders 3, 5, 7 and 9 (one channel), and overall distortion factor and overall RMS value.

Real-Time RMS Measurement Function

Real-time RMS Measurement mode can be set separately for each channel. This function is effective for monitoring for fluctuations in the root mean square value of power supply waveforms, etc. In addition, root mean square value fluctuation triggers can also be sensed.

OR100E/OR300E Recorder Specifications

Measurement input

Input type: Floating unbalanced input, I/O isolation (channel independence)
 Input mode: DC, GND, RMS (RMS is for OR300E only)
 Measurement range and accuracy: See table below.

(After zero-calibration following 30-minute warm-up at 23 ± 5°C)

Measurement range (V/div)	Measurable range	Accuracy
100mV FS(10mV/div)	± 100.0mV	± (1% of FS + 1mV)
200mV FS(20mV/div)	± 200.0mV	± (1% of FS + 1mV)
500mV FS(50mV/div)	± 500.0mV	± (1% of FS + 1mV)
1V FS(100mV/div)	± 1.000V	± (1% of FS + 1mV)
2V FS(200mV/div)	± 2.000V	± (1% of FS + 1mV)
5V FS(500mV/div)	± 5.000V	± (1% of FS + 1mV)
10V FS(1V /div)	± 10.00V	± (1% of FS + 1mV)
20V FS(2V /div)	± 20.00V	± (1% of FS + 1mV)
50V FS(5V /div)	± 50.00V	± (1% of FS + 1mV)
100V FS(10V /div)	± 100.0V	± (1% of FS + 1mV)
200V FS(20V /div)	± 200.0V	± (1% of FS + 1mV)
500V FS(50V /div)	± 500.0V	± (1% of FS + 1mV)
1000V FS(100V /div)	± 500.0V	± (1% of FS + 1mV)

Zero position: Can be moved within measurement range; null function included.
 Frequency characteristics (with filter off): DC to 40 kHz (+1/-3 dB, typical)
 Common mode rejection ratio (CMRR): 85 dB or greater (50/60 Hz; signal source resistance of 500 Ω or less)
 Low-pass filter: 5 Hz, 500 Hz, off
 Attenuation characteristic: -6 dB/octave
 Noise (with filter off, 10 mV/div range input shorted): 2.0 mVp-p (typical)
 AD resolution: 12 bits (equivalent to 11bit internal processing resolution)
 Maximum sampling speed: 400 kS/s (all channels simultaneously); 80 kS/s in wave-window
 Input impedance: 1 MΩ ± 1%, 5 pF (at 40 kHz, typical)
 Input terminal: Safety terminal (for banana plug)
 Maximum input voltage and maximum floating voltage: Between H and L input terminals, between H-L input terminal and ground

Overvoltage category	Maximum input voltage
CATII environment	500 Vrms
CATIII environment	300 Vrms

Temperature input (with temperature input adapter)

Scale: Both upper and lower limits can be set in increments of 108C.
 Position: Can be moved in increments of 108C.
 Low-pass filter: 5 Hz (fixed)
 Measurement range and accuracy: (at temperature of 23658C, following 30-minute warmup period)

Measurement range	Measurement span	Measurement accuracy
2008C range	-50 to 2008C	±28C
4008C range	-50 to 4008C	±38C
6008C range	-50 to 6008C	±58C

Memory function

Time axis: 200, 500 μs/div
 1, 2, 5, 10, 20, 50, 100, 200, 500 ms/div
 1, 2, 5, 10, 30 s/div
 1, 2 min/div
 Time axis resolution: 80 points/div (measurement period is 1/80 of time axis)
 Memory recording length: 10, 20, 50, 100, 200, 400, 800, 1600, 3200*1, 6400*2 div
 *1: Only works on odd-numbered channel when two channels are connected together.
 *2: Only works on channel 1 when four channels are connected together.
 Number of memory division blocks: 32 maximum--varies depending on installed memory length, set memory length and whether or not wave window trigger is used.
 Auto functions: Automatic printing, automatic statistical calculations, automatic saving (to external memory), automatic dialing (for faxing)
 Cursor functions: One cursor: Measurements on all channels displayed simultaneously.
 Two cursor: Time on all channels, as well as measurement differences or frequencies
 Cursor calculation function: max/min/ave/rms for cursor range, surface area of cursor range

Recording

Recording paper: Thermal paper roll (111 mm (width) X10 meters), effective recording width: 104 mm
 Paper feed accuracy: ±3%
 Chart speeds: 2, 5, 10, 30 s/div; 1, 2, 5, 10, 30 min/div; 1 hour/div

Recording formats

T-Y recording: 4 analog channels + 8 logic bits; 1, 2, and 4 division recording capability (logic recording can be turned on/off separately for each bit) measurements are recorded as digital values.
 Digital recording: X1-Y1, Y2, Y3. X axis is always 1 channel only.
 X-Y recording: Recording size: 8 div X 8 div (80 mm X 80 mm)
 Recording format options: Dots, lines
 Recording length: 20 div, 200 div, 800 div, continuous
 Recording line types: Three line thicknesses (analog waveforms)

Printing function

Printed information: List (settings), scale (units), time print marker, chart speed, chart speed modification point marker, trigger sensing position, trigger time, trigger sensing channel, grid (thin line, baseline, off), channel number, TAG, etc.
 Comments: Character string (20 characters per channel) or channel information printed in 100 mm intervals.
 Channel number: Channel number or TAG name (7 characters per channel) printed on waveform.

Real-time & memory

Description of operations: Normally memory sampling starts when trigger is detected during real-time recording.

Normal Trigger

Trigger sources: Analog channels 1-4, logic A and B, external trigger input, manual, timer
 Trigger modes: Free, Single, Repeat
 Trigger combinations (conditions): AND/OR
 Analog trigger types: Rise, fall, high, low, bi-slope, level window (in, out)
 Trigger level setting: 1% FS increments

Trigger filter: Filter or time-out (except when bi-slope is set)
 Trigger delay: -100% to 100% (in increments of 1%)

Wave-window trigger

Trigger modes: Single, repeat, free
 Frequencies: 50 Hz, 60 Hz
 Trigger combinations (conditions): OR on each analog channel
 Method for creating reference waveform: Automatically generated from current input or specified parameters
 Reference waveform parameters: Amplitude, tolerance, offset (1% increments for each), phase (in increments of 1°)
 Trigger delay: -100% to 100% (in increments of 10%)
 Sampling rates: 80 kS/s (1 ms/div), 40 kS/s (2 ms/div), 16 kS/s (5 ms/div), 8 kS/s(10 ms/div)
 Memory length: Memory cannot be linked; maximum memory length for each channel is one-half that of normal triggers.
 Maximum memory length: 800 div

Display

Screen: 5.7-inch LCD, 480X320 dots, contrast adjustable
 Backlight: Fluorescent tube, can be turned on/off manually
 Display languages: Japanese, English, Germany, French, Italy

Harmonic Analysis Mode Specifications

Fundamental wave: 50 Hz, 60 Hz or automatic (45.0 Hz to 65.0 Hz; Automatic Analysis mode only)
 Sampling rates: 25600 Hz (50 Hz), 30720 Hz (60 Hz)
 Analysis data points: 512
 Analysis orders: Fundamental wave to 40th order
 Analysis modes: Waveform Analysis, Automatic Analysis
 Sample length (in Waveform Analysis mode): 5-250 cycles, maximum 1000 cycles (4 channels linked)
 Anti-aliasing filter: Cutoff frequency: 7.5 kHz, -30 dB/oct
 Effect on analyzed range caused by aliasing: -40 dB or less
 Amplitude accuracy (voltage, current) **:
 Fundamental wave to 20th order ± (1.5% of rdg + 1.5% of FS)
 21st to 40th orders ± (1.5% of rdg + 2% of FS)
 Phase accuracy (voltage and current to fundamental wave phase tolerance) *1 *2:
 2nd order to 10th order: ±5 deg, 11th order to 40th order ±15 deg
 *1) In 50/60 Hz fixed mode (not including current clamp accuracy)
 *2) Harmonic amplitude: At FS/100 to FS
 Analyzed frequency range: 45 to 2.6 kHz (65 Hz X 40)
 Triggers: Same as OR100 trigger functions in Waveform Analysis mode (but trigger sensing rate depends on sampling rate).
 Triggers available in Automatic Analysis mode: Synchronized channel and level trigger settings, distortion factor and content of specified order.
 Analysis types: Root mean square value, content and phase angle for harmonic component of each order; and active power*, power content*, and phase angle* (overall root mean square value, overall distortion factor; active/reactive/apparent power, and power factor can be displayed)
 *: The following power measurement method is used (only works in Automatic Analysis mode; voltage output from a clamp probe is scaled to current values):
 Single-phase two-wire method (in the 4-channel model, two single-phase two-wire systems can be measured), single-phase three-wire method, three-phase three-wire method
 Saving analysis results to PC card: Analysis results can be saved to aflesh ATA memory card.
 Data format: CSV
 Saving methods: Manual and automatic (for saving continuous trends at specified intervals)
 Trend saving parameters: Root mean square value, content, phase angle, overall root mean square value, overall distortion factor, activepower, power content, phase angle, total active power, apparent power, reactive power, and power factor. Analysis trends and number of orders for saving trends to PC card can be selected separately for each channel.
 Trend saving intervals: 1 minute, 10 minutes, 30 minutes, 1 hour, 24 hours

Real-time RMS measurement

Frequency ranges: DC, 40 Hz to 1 kHz
 Measurement range: 100 mVrms to 500 Vrms
 Measurement accuracy: As shown below for 50/60 Hz, sine wave
 100 mV FS to 2 V FS: ± (2% of FS + 1 mV)
 5 V FS to 50 V FS: ± (2% of FS + 50 mV)
 100 V FS to 1000 V FS: ± (2% of FS + 0.1 V)
 Response rate: (for 0-100% of FS step input)
 Rise (0 → 90% of FS): 200 ms (typical)
 Fall (100 → 10% of FS): 310 ms (typical)
 Crest factor: 2 (measurable range for crest factor 2 is rms value of no more than 90% of f.s.)

External I/O interface

Terminal: Screwless terminal
 External trigger input: TTL level or contact (pulse width of 2 μs or greater)
 Depending on settings, can be used as input for external sampling clock (up to 100 kHz) or for starting/stopping measurement.
 External trigger output: TTL level (pulse width of 10 ms or greater; for parallel operation)

RS-232 interface

Connector: 9-pin DSUB connector (male)
 Transfer rates: 1200, 2400, 4800, 9600, 19200 bps

PC card interface

External memory:
 Supported card: Flash ATA memory card (made by SanDisk Corporation or equivalent)
 Supported card sizes: Up to 160 MB
 Function specifications: Saving settings data, measurement data, and graphical images (BMP)
 Saving formats: ASCII, binary, BMP
 Modem communications:
 Supported card: Fax/modem card
 Transmission rate: 19200 bps maximum
 Fax control: EIA-592 Class 2 card must be used.
 Function specifications: Sending measurement data, receiving setting commands, automatic transmission of measurement data (fax only)

Data recorder function

Maximum sampling rate: 1.6ks/s

Data length for playback on recorders: 128k data/ch steps

Note: Does not support external sampling. Only normal trigger mode is available. Trigger-ready is always 0%. Repeat trigger cannot be used.

Operation-verified PC cards

- Flash ATA memory card
I/O DATA, Epson, Panasonic

Logic Probes (sold separately)

	788031	788035
Input type	4-channel, TTL or contact input; common input in the same probe.	4-channel, voltage input; insulation between channels.
Maximum allowable input voltage	±35 VDC	±250 Vrms
Input impedance	Approximately 10 kΩ	Approximately 100 kΩ
Threshold level	Approximately +1.4 V	Sensed: 60-250 VAC, ±30±250 VDC Not sensed: 0-10 VAC, 0-±10 VDC
Withstand voltage	500 VDC, 1 minute (between probe and case)	1.5 kVAC, 1 minute (between channels) 1.5 kVDC, 1 minute (between probe and case)

788041-1 Temperature input adapter (sold separately by Yokogawa M&C Corporation)

Attachable sensor type: Type K thermocouple

Number of attachable sensors: One per adapter

Terminal type: Clamp-on

Temperature range: -50 to 600°C

Note: Thermocouples are not included and must be purchased separately by the user. Temperature input adapter model 788041 works with OR100E and OR300E only. It does not work with OR100 or OR300.

96001 Clamp probe (sold separately by Yokogawa M&C Corporation)

Measurement range: 0-400 Ams AC (600 Apk)

Output voltage: 10m V/A (4V AC max.)

Accuracy

- Amplitude: ±1.5%rdg ±0.4 mV (20-40 Hz)
±1.0%rdg ±0.2 mV (40 Hz - 1 kHz)
±(0.8 + 0.2 X f kHz) %rdg
±(0.2 + 0.04 X f kHz) mV (1-20 kHz)
- Phase: ±38(40 Hz - 1 kHz)

(Conditions: 238C ± 58C, max. 80%RH, sinewave input)

Measurable conductor diameter: 33 mm max.

External dimensions (mm): Approximately 73 X 130 X 30 (WHD)

Output cable length: 2.5 m

Other separately sold accessories

- Dedicated AC adapter (sold separately)

- Rated supply voltage: 100 to 240 VAC
Permissible supply voltage fluctuation range: 90 to 264 VAC
Rated supply frequency: 50/60 Hz
Permissible supply frequency fluctuation range: 48 to 62 Hz
Maximum consumed power: 70 to 90 VA
Rated output voltage: 12 VDC
Rated maximum output current: 2.6 A

- Dedicated NiMH battery pack (sold separately)

Battery volume: 2100 mAh, 7.2V

Number of charges (cycle life):

- Running time: Approximately 300 (varies depending on usage environment)
Approximately 3.5 hours (on trigger standby without options)
Approximately 3 hours (when recording 1 Hz cycle waveform in 2 S/div)
- Charging function: Charged in the recorder, connect the dedicated AC adapter and turn off the power switch to enter charge mode. Charging time is approximately 1.5 hours.

- DC converter (sold separately)

Allowed input voltages: 788025-1: 9-18 VDC
788025-2: 18-36 VDC
788025-3: 36-60 VDC

Output voltage: 12V ± 5%

Power consumption: Approximately 25VA maximum

Terminal type: Screw terminal (lead wire approximately 5 meters long included)

General specifications

Measurement modes: Memory, Real-Time Recorder, Real-time Recording & Memory, Harmonic Analysis (OR300E only)

Channels: Analog: 2 channels or 4 channels

Logic: 8 bits (maximum of 2 four-bit probes can be connected)

Internal memory capacity:

128K per channel (or 256K data per two linked channels, 512K data per four linked channels)

Internal memory type: SRAM (battery backup)

Power supply: Commercially available AA alkaline dry cells or special AC adapter, special NiMH battery pack, special DC converter for external DC power source.
When both the AC adapter and batteries are connected, the AC adapter is used first.

Power consumption: Using AC adapter: 25 VA maximum

Using batteries: 20 VA maximum

AA/R6 dry cells: Six AA/R6 alkaline dry cells (JIS, IEC model name: LR6)

Alkaline dry cell running time:

Approximately 2 hours (on trigger standby without options)
Approximately 1/2 hour (when recording 1 Hz cycle waveform in 2 S/div) (about 10 minutes shorter with OR300E)

Warm-up time: 30 minutes

Withstand voltages: Between recorder and special AC adapter power line: 2 kVAC for 1 minute
Between recorder and analog input terminal: 2 kVAC for 1 minute
Between input terminals: 2 kVAC for 1 minute

Insulation resistance: Between recorder and special AC adapter power line: Minimum 10 MΩ at 500 VDC

Between recorder and analog input terminal: Minimum 100 MΩ at 500 VDC

Between input terminals: Minimum 100 MΩ at 500 VDC

Allowed signal source resistance: Maximum 500Ω

Environment: Usage temperature and humidity: 5 to 40°C, 35 to 80% RH (Note: Wet-bulb temperature of 29°C or less, no condensation.)

Storage temperature and humidity: -20 to 60°C, 90% RH (Note: Wet-bulb temperature of 29°C or less, no condensation; NiMH battery and alkaline dry cells not included.)

Clock accuracy: ±100 ppm (typical)

Battery backup: Lithium battery for backing up settings, waveform data and clock
Life of lithium battery for backup: Approximately 5 years (at room temperature)

External dimensions: Approximately 256 (H) X 190 (W) X 46 (D) mm

Weight: OR122 (2-channel model): Approximately 1.3 kg (not including batteries or chart)
OR142 (4-channel model): Approximately 1.4 kg (not including batteries or chart)
OR322 (2-channel model): Approximately 1.4 kg (not including batteries or chart)
OR342 (4-channel model): Approximately 1.5 kg (not including batteries or chart)

Accessories: Printer paper (111 mm X 10 meter roll; part number: B9988AE); 1 roll
Measurement input leads for voltage input (model 366963); Leads for each channel
AA/R6 alkaline dry cells (part number: A1070EB): 6
Belt (part number: B9988CK): 1 set
Instruction Manual: 1

ACRAWin32 PC software

Data display: Displays waveform data measured and saved using OR100E, OR300E, OR1400. (supported recorders differ depending on software model)
OR300E harmonic analysis results cannot be redrawn.

Data conversion: Conversion to ASCII, Lotus 1-2-3 and Excel formats.

Number of displayed waveforms:

Maximum simultaneous display of 16 analog waveforms and 16 logic waveforms (displayed separately for each file; maximum number of simultaneous waveforms varies depending on model)

Calculation function: Use cursor to select range on waveform display screen or digital value display screen. Minimum, maximum, P-P, average and root mean square values are calculated.

Communication with recorders (destinations):

Enter the desired recorder name, and set details such as the access method, communicated information schedule, data type selection, and password during communication. Next start or stop communication (OR100E/OR300E only).

PC:

The PC must be running Windows 95, 98 or Windows NT 4.0 or higher, have a Pentium 90 MHz CPU or higher, have at least 16 MB of RAM and at least 5 MB free hard drive space.

Serial port and modem: For communication between a PC and the OR100E/OR300E using the OR100E/OR300E Connector communication software, the PC must be connected through a serial port (RS-232) or modem. In addition, the operating system must recognize the communication devices.

RS-232 cable and adapter:

For serial communication, an RS-232 cable with reverse-connected

System Components

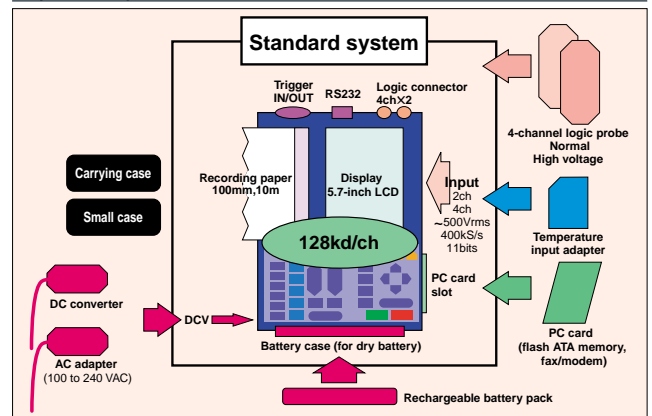

Supported standards

CSA	Obtained CSA22.2 No.1010.1 Installation category (Overvoltage category) : II, III Degree of pollution : 2	
CE	EMC directive	EN61326
		EN61000-3-2
		EN61000-3-3
	EN55011 Class A Group 1	
Low voltage directive	EN61010-1	
	Measurement category : II, III Degree of pollution : 2	
C-Tick	AS/NZS 2064 Class A Group 1	

Peripheral Equipment



788011
AC adapter



788021
Rechargeable battery pack



788025
DC-DC converter



788031
Logic probe (±35VDC)



788035
Logic probe (±250Vrms)



788081
Carrying case



788082
Small case

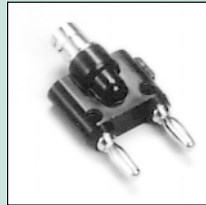

366922
Conversion adapter

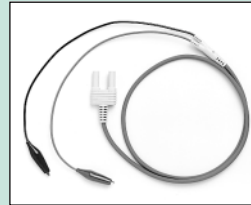

366963
Measurement lead



96001
Clamp probe*



788041
Temperature input adapter

*:Product of YOKOGAWA M&C Corporation

Model and suffix codes

OR100E (standard model)

Model	Suffix code	Description
OR122		2-channel isolated input model*
OR142		4-channel isolated input model*
Display language	-2	English (including key panel)
Options	/P □***	Accessory pack**

OR300E (harmonic analysis model)

Model	Suffix code	Description
OR322		2-channel isolated input model*
OR342		4-channel isolated input model*
Display language	-2	English (including key panel)
Options	/P □***	Accessory pack**

* : Standard-equipped with measurement cables for each analog input channel.
 ** : Includes AC adapter, rechargeable battery pack and carrying case (788081).
 ***: D (for UL/CSA), F (for VDE), R (for SAA), S (for BS), H(for CCC)

Separately sold accessories

788011		AC adapter
	□*1	Power code
788021		Rechargeable battery pack *2
788025		DC converter
	-1	For connecting external 12 VDC power supply
	-2	For connecting external 24 VDC power supply
	-3	For connecting external 48 VDC power supply
788031		4-channel logic probe *3
788035		4-channel high voltage logic probe (each channel isolated) *4
788041		Temperature input adapter
	-1	For type K thermocouple
788081		Carrying case
788082		Small carrying case

*1: D (for UL/CSA), F (for VDE), R (for SAA), S (for BS), H(for CCC)

*2: Be sure to get an AC adapter (788011) if you are getting a rechargeable battery pack.

*3: Includes IC clip and crocodile leads.

*4: Includes crocodile leads.

PC Software

789501		Viewer for OR100E/OR300E only and OR100E/OR300E connector software
789502		Viewer software for OR100E/OR300E, OR1400 and ORM
789503		Viewer software for OR100E/OR300E, OR1400 and ORM, and OR100E/OR300E connector software
	-02	English

Accessories

B9988AE		111 mm x 10 meter roll paper
---------	--	------------------------------

NOTICE

- Before operating the product, read the instruction manual thoroughly for proper and safe operation.
- If this product is for use with a system requiring safeguards that directly involve personnel safety, please contact the Yokogawa sales offices.

YOKOGAWA

YOKOGAWA ELECTRIC CORPORATION
 Test and Measurement Business Div./Phone: (81)-55-243-0313, Fax: (81)-55-243-0396
 E-mail: tm@csv.yokogawa.co.jp

YOKOGAWA CORPORATION OF AMERICA Phone: (1)-770-253-7000, Fax: (1)-770-251-2088
 YOKOGAWA EUROPE B.V. Phone: (31)-33-4641806, Fax: (31)-33-4641807
 YOKOGAWA ENGINEERING ASIA PTE. LTD Phone: (65)-62419933, Fax: (65)-62412606

Subject to change without notice.
 [Ed : 04/b] Copyright ©1998
 Printed in Japan, 402(YG)