

Discover What's Possible™

Anritsu

# MS2663C

## Spectrum Analyzer

9 kHz to 8.1 GHz

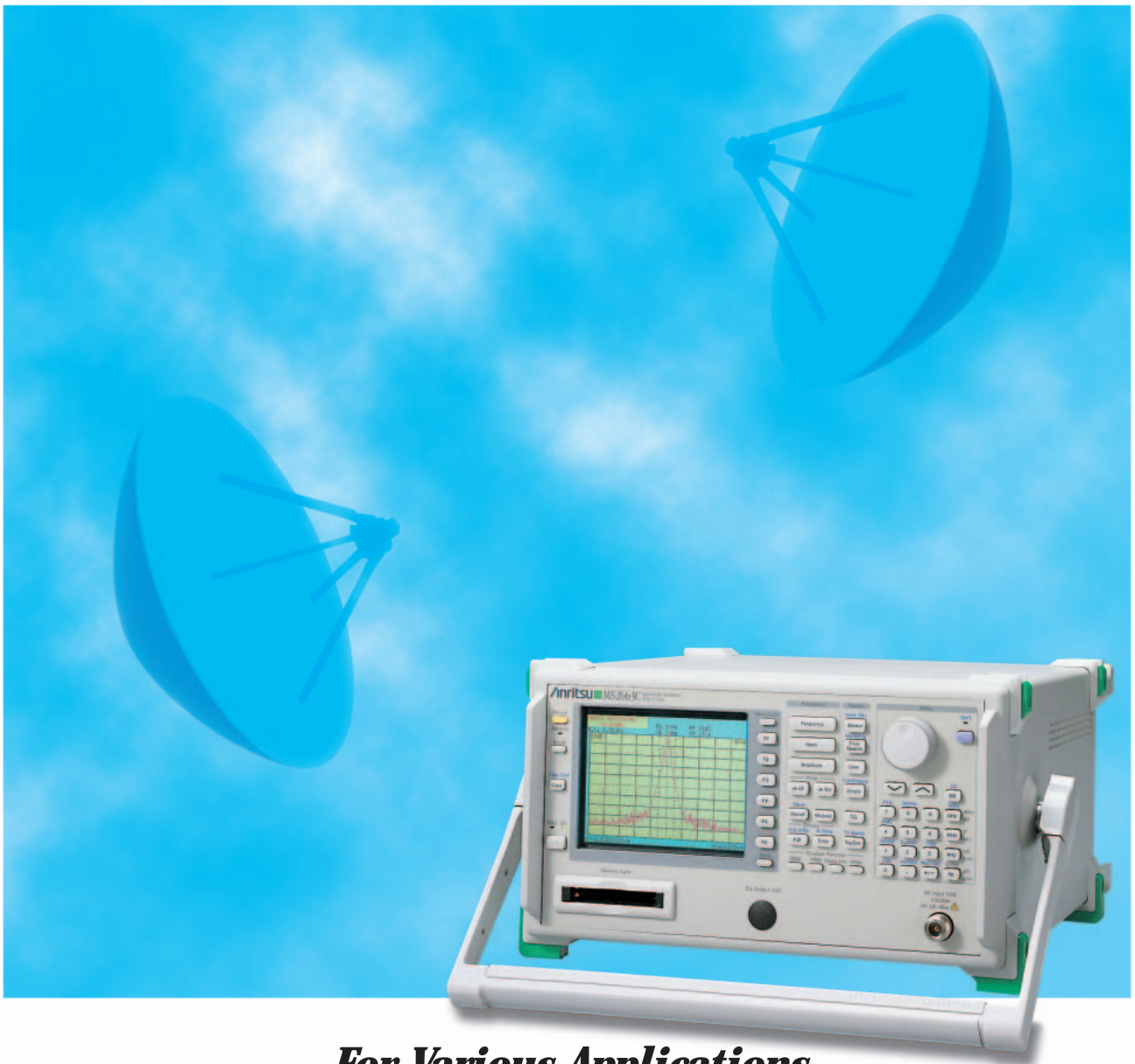

***For Various Applications***

# *Portable at Only 13.5 kg*

The MS2663C covers a frequency range of 9 kHz to 8.1 GHz. This allows measurement of spurious frequencies of up to three times greater than the frequency bands used worldwide for mobile communications.

The MS2663C has superior basic performance such as high C/N ratio, low distortion, and high frequency/level accuracies and is easy to operate. In addition, a Gaussian filter is used as the resolution bandwidth filter. The large selection of options means a wide range of applications can be handled at reasonable cost.

## ■ Compact and lightweight (13.5 kg in standard configuration)

- Easy portability for installation and maintenance

## ■ High C/N and superior distortion characteristics

- Measurement speed improved by using 100 dB log dynamic range

## ■ Easy-to-use, simple operation

- Built-in “Measure” function for evaluation of radio equipment (Frequency counter, C/N, channel power, adjacent channel power, occupied frequency bandwidth, burst average power and template pass/fail function)
- User-defined function
- Zone marker/zone sweep
- Two-screen display
- FM demodulation waveform display



- Memory card interface (for saving/recalling trace data and parameter and for saving screen image in bitmap format)

■ **Options support wide range of applications**

- High stability crystal oscillator
- Narrow resolution bandwidth
- High-speed time domain sweep
- Trigger/gate circuit
- AM/FM demodulator
- Pre-amplifier
- Centronics interface (can not be installed GPIB simultaneously)
- QP detector
- Television monitor
- Tracking generator

■ **Easy to set up automatic measurements**

- Controller function built-in (PTA)
- Built-in RS-232C and GPIB (standard)
- Various application software





# Compact, Lightweight, and Powerful

- **Small and weighing only 13.5 kg**

The MS2663C is compact and lightweight, measuring 320 (W) x 177 (H) x 351 (D) mm and weighing only 13.5 kg. In addition to benchtop use, this can be carried easily for field use, making it the ideal choice for manufacturing and maintenance of radio equipment.

- **Synthesized local oscillator**

The synthesized local oscillator design permits stable measurement without disturbance due to frequency drift of the spectrum analyzer itself. The level stabilizes in 30 minutes after power-on, making this unit especially suitable for on-site maintenance and adjustment where work must be completed quickly.

- **Counter with 1 Hz resolution**

A full complement of frequency counter functions are provided. Resolution is a high  $\pm 1$  Hz even at full span, and high-speed frequency measurements can be performed. The high sensitivity compared with ordinary counters makes it easy to select one signal from many and to determine its frequency.

- **High C/N ratio**

Excellent noise sideband characteristics are required for analysis of weak signals adjacent to strong signals. The MS2663C has low noise sidebands of below  $-100$  dBc/Hz (10 kHz offset), making it suitable for measurement of adjacent channel power of both analog and digital radio communication equipment.

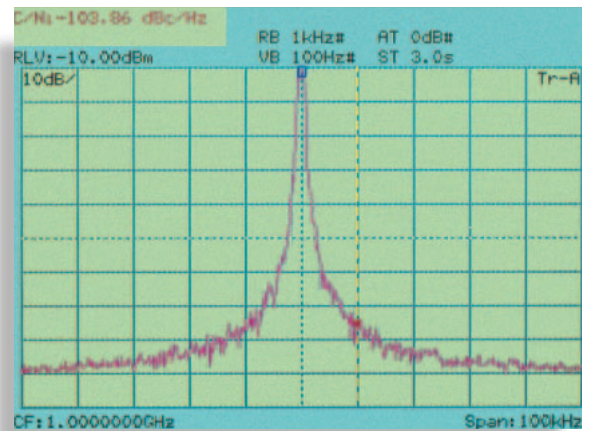

Noise sidebands measurement (10 kHz offset)

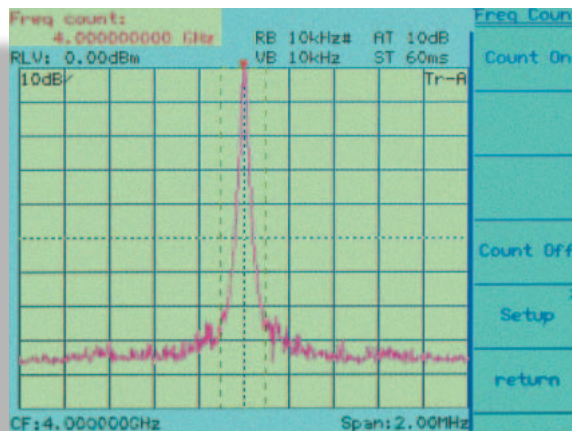

Frequency measurement (1 Hz resolution)

**• Superior distortion characteristics**

The MS2663C boasts extremely low harmonic distortion levels, including a second harmonic distortion of  $-75$  dBc\*<sup>1</sup> and a two-signal third order intermodulation distortion of  $-80$  dBc\*<sup>2</sup> making it suitable for measuring harmonic components and for evaluating the non-linearity of high-power amplifiers.

\*<sup>1</sup> 200 MHz to 1.3 GHz, mixer input:  $-30$  dBm

\*<sup>2</sup> 100 MHz to 8.1 GHz, frequency difference between signals:  $\geq 50$  kHz, mixer input:  $-30$  dBm

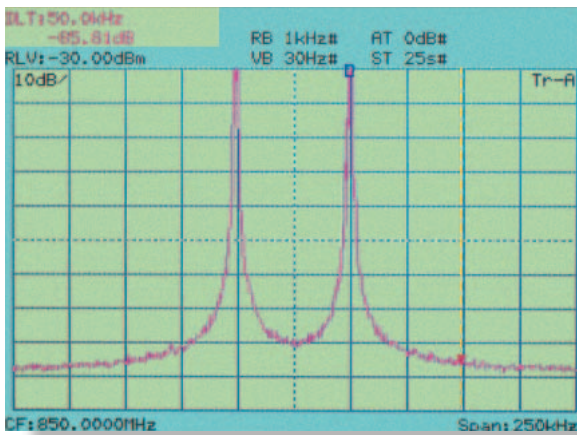

Two-signal third order intermodulation measurement

**• Highly-accurate measurement**

Auto-calibration ensures an overall level accuracy of within  $\pm 1.3$  dB (100 kHz to 3.1 GHz). A span accuracy of 2.5% and 501 sampling points ensure accurate occupied frequency bandwidth and adjacent channel power measurements.

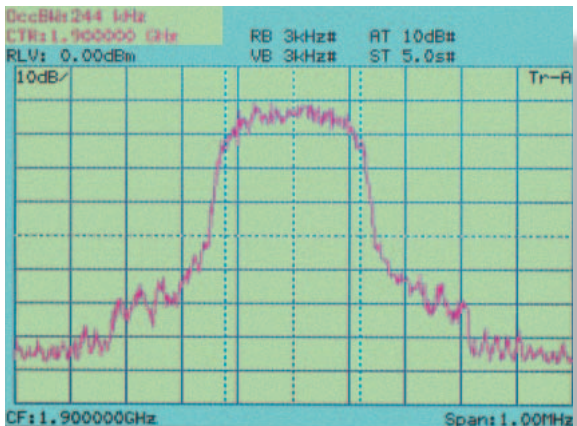

Occupied bandwidth measurement

**• 100 dB display dynamic range**

In measurements requiring a wide dynamic range such as adjacent channel power measurements, MS2663C can displayed more than 80 dB on a single screen.

**• Excellent cost performance**

The superior basic performance, including noise sideband, average noise level, and spurious response, provides excellent cost performance.

Noise sideband* <sup>1</sup>	$\leq -100$ dBc/Hz
Average noise level* <sup>2</sup>	$\leq -115$ dBm
Maximum distortion dynamic range	2nd harmonic: >80 dB (200 to 500 MHz) 3rd intermodulation distortion: >83.3 dB (100 to 1000 MHz)

\*<sup>1</sup> 1 GHz, 10 kHz offset

\*<sup>2</sup> 1 MHz to 1 GHz, RBW: 1kHz, VBW: 1 Hz, RF ATT: 0 dB

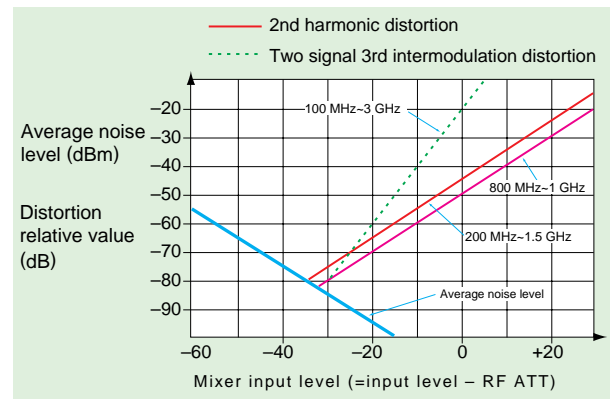

Distortion characteristics

# Convenient Easy-to-Use Functions

- **Simple operation**

Users require ease of operation in a wide variety of contexts. For greater ease, in addition to simplifying the panel keys and key layout, also menu page configuration is well organized and “page-learning” as well as “user-defined” functions have been added to minimize the steps required for a given procedure.

- **Bright color screen**

A 5.5” bright color TFT LCD is used to display scales, measured waveform data, settings and other information in different easy-to-read colors. Each color can be changed if required. When the soft key display is turned off, the scale area enlarges to 80 (H) x 180 (W) mm, comparable to an 8” CRT.

- **Radio equipment evaluation functions (“measure” functions)**

A full range of functions including measurement of power levels, frequencies, adjacent channel power, and mask and time template measurements are provided for performance evaluation of radio equipment. Key operation is simple and high-speed calculations make the measurement fast and efficient.

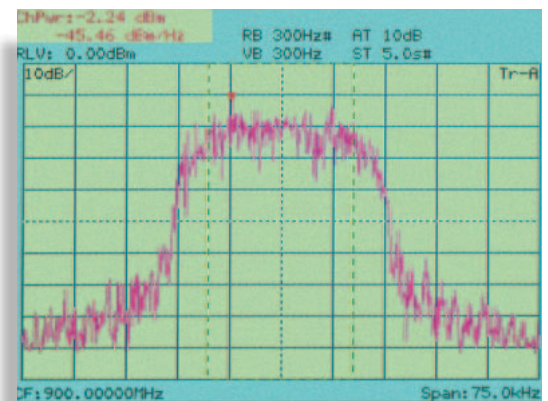

Channel power measurement

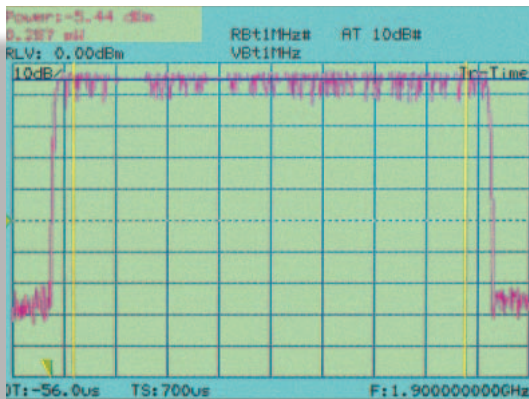

Burst average power measurement

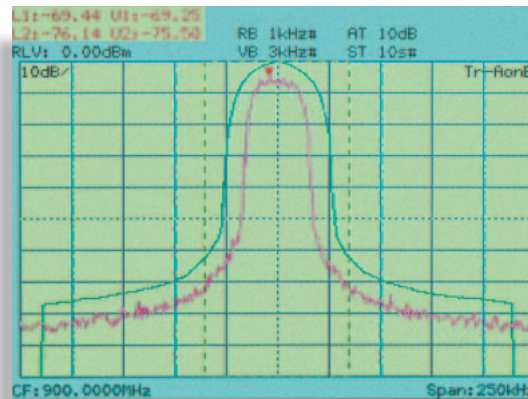

Adjacent channel power measurement

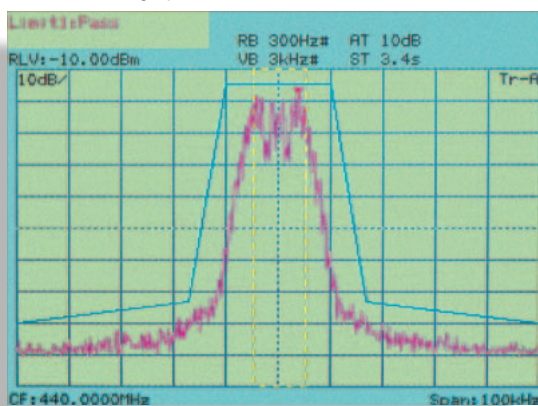

Mask measurement

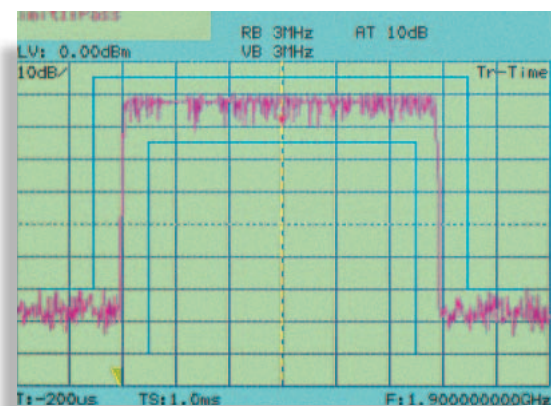

Time template measurement



**● FM-demodulated waveform display function**

This function displays FM-demodulated waveforms with an accuracy of 5% over the range  $\pm 10$  kHz to  $\pm 1$  MHz. When used with high-speed time domain sweep (Option 04) and trigger/gate circuit (Option 06), frequency deviation of the modulated signal, and frequency switching times of radio equipment and VCOs, can be measured.

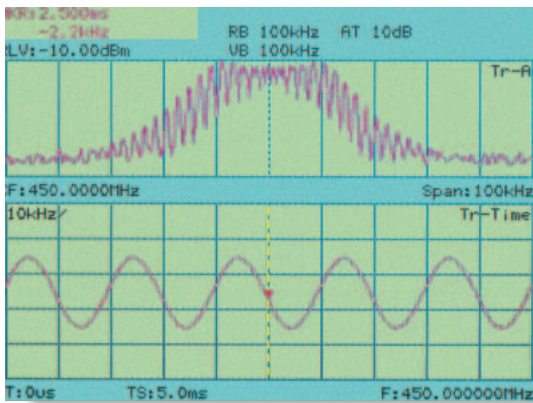

Spectrum and FM-demodulation waveform

**● Zone markers and multimarkers**

Zone markers can be set automatically at the peak signal within a given marker range, enabling quick measurement. By using the multimarker function, automatic measurements can be performed at up to ten marker points, and the results displayed in a table. Multimarkers have functions for harmonic measurements, highest 10 points and manual setting.

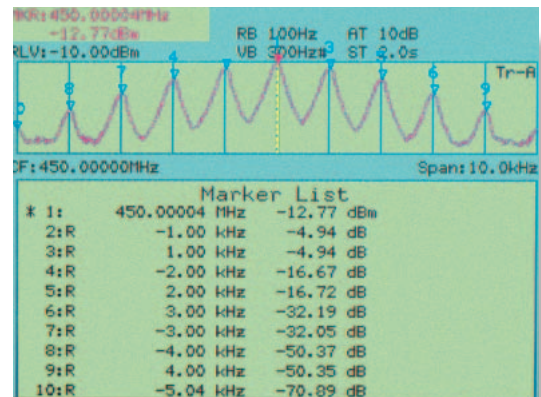

Multi marker (highest 10 points)

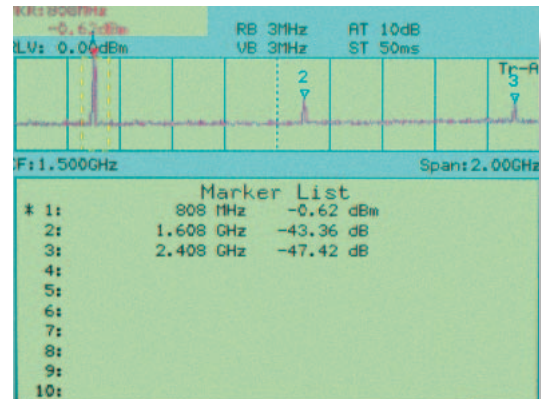

Multi marker (harmonics measurement)

● **Zone sweep and multi-zone sweep functions**

Sweeps can be limited to zones defined by zone markers reducing sweep time. This zone sweep function can be combined with “measure” functions such as “noise measure” which can direct readout the total noise power within the zone, and reduces measurement time greatly. The multi-zone sweep function enables up to ten zones to be swept.

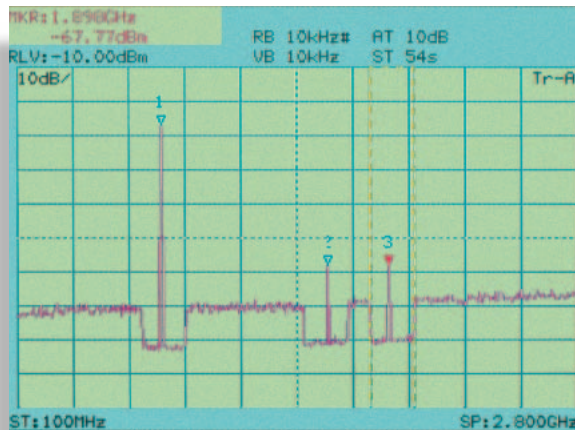

Multi-zone sweep

● **Multi-screen display**

The Trace-A and Trace-B waveforms are superimposed on the same screen, and two spectra with different frequencies are displayed simultaneously. In addition, it is possible to simultaneously display spectrum and time domain screens for the same signal. The multi-screen display permits efficient signal level adjustment and harmonic distortion measurement, too. Furthermore, in addition to being able to display amplitude in the time domain, it is also possible to display the FM demodulation waveform.

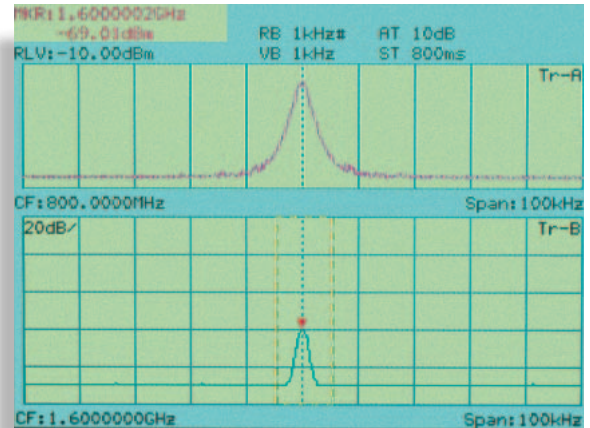

Two traces with different frequencies

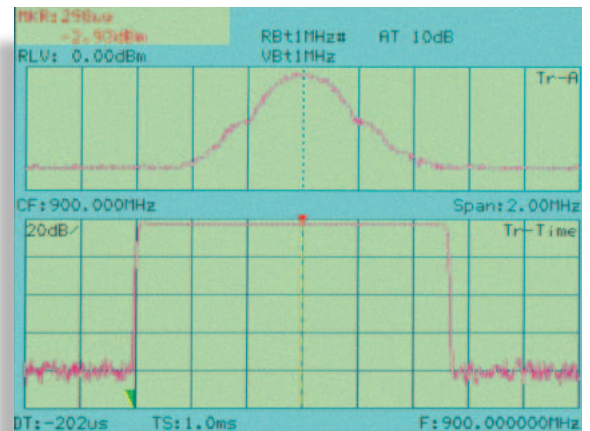

Spectrum and time domain measurement



**● User-defined functions**

Measurement programs downloaded to the spectrum analyzers from a personal computer or memory card can be executed by defining menu keys. The measurement program is executed simply by pressing the predefined key, with no further operation. Other panel and function keys can also be predefined in the same way.

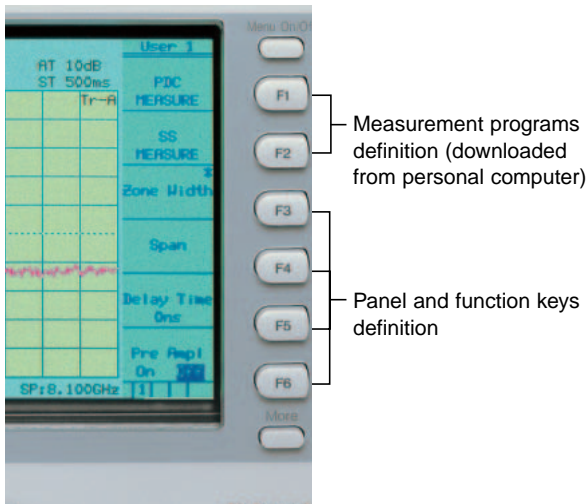

User-defined menu

**● Screen image bitmap saved to memory card**

Instead of printing a hard copy of the screen, it is also possible to save the screen image to a memory card in bitmap format. Editing the saved bitmap data using a PC, makes report writing easy.

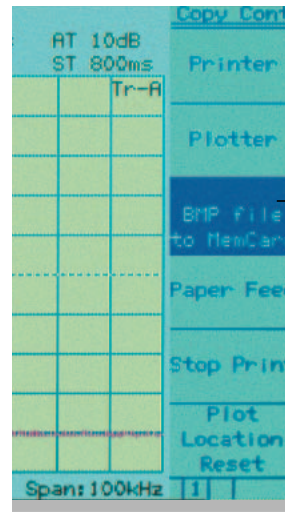

When the mode to save the screen image in bitmap format to the memory card is selected as a copy method at the hard copy function, just one press of the copy key saves the screen image as a bitmap format to the memory card. And the file number of each saved file is incremented automatically.

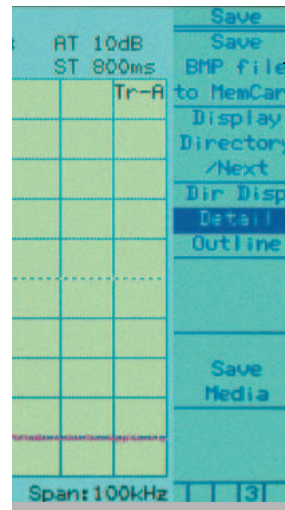

The screen image data can also be saved to the memory card using the save function. In this case, the file number of the saved file can be specified.

# Full Range of Options

Full lineup of options to select required performance and functions with minimum capital investment.

- **To boost basic performance**

- High-stability reference oscillator**

- (Option 01)**

Adding the optional reference oscillator with a stability of  $2 \times 10^{-9}$ /day and  $1 \times 10^{-7}$ /year increases the accuracy of frequency measurements even further.

- Narrow resolution bandwidth (Option 02)**

Adding the option for a resolution bandwidth of 30 Hz, 100 Hz and 300 Hz greatly improves frequency resolution.

- Pre-amplifier (Option 08)**

The Pre-amplifier improves the sensitivity (noise figure) of the spectrum analyzer, and is best used when studying interference signals and other low-power signals. It covers a frequency range from 100 kHz to 3 GHz.

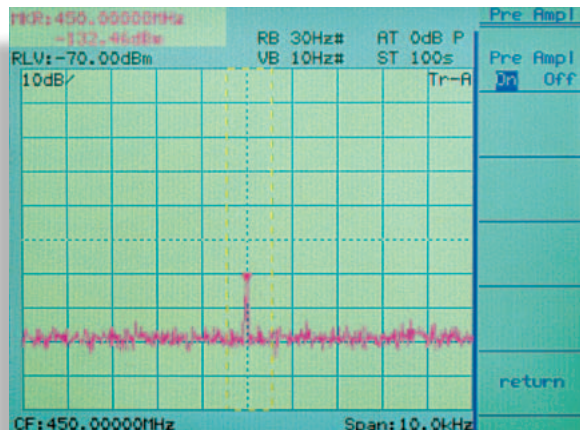

Low-power signal measurement using RF pre-amplifier

- **For testing digital mobile communication equipment**

- High-speed time domain sweep (Option 04)**

Testing of TDMA-type radio equipment includes time domain (zero-span) measurements of antenna power, transient response characteristics of burst transmissions, transmission timing, and other quantities. The high-speed time domain sweep option boosts a sweep time to 12.5  $\mu$ s and resolution to 0.025  $\mu$ s. This option must be used with the trigger/gate circuit (Option 06).

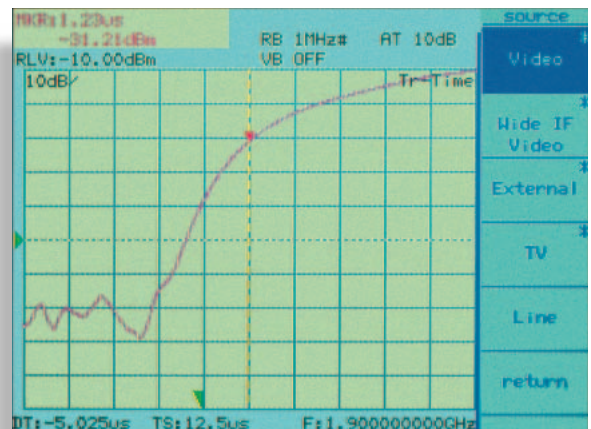

High-speed time-domain measurement (TS=12.5  $\mu$ s)

### Trigger/gate circuit (Option 06)

Burst signal and TV signals etc. can be stably measured using the trigger function in time-domain measurements. One of the external, video, wide IF video, line or TV is selectable. This makes a variety of TDMA radio equipment tests possible, including template comparison using pre-trigger and post-trigger delay functions, and gate spectrum analysis using the gate sweep function. Previously, the trigger output from an external detector was required in gate spectrum analysis. However, this option for the MS2663C has a 20 MHz wide IF video trigger function, eliminating the need for trigger output from an external detector.

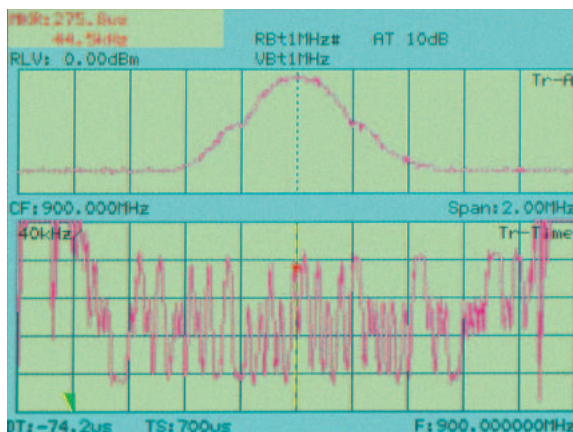

Wide IF video trigger function

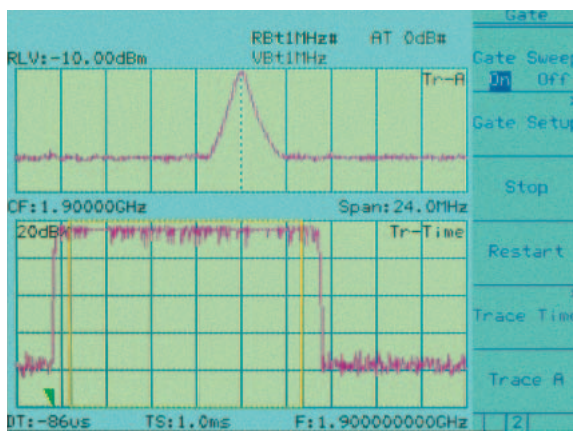

Wide IF video trigger and gate functions

### • For CATV maintenance

#### 50 $\Omega$ /75 $\Omega$ impedance transformer

Converts RF input impedance to 75  $\Omega$

#### AM/FM demodulator (Option 07)

Demodulates AM/FM signals, enabling audio monitoring using internal speaker or earphones. This is useful for distinguishing between noise and signals.

#### Television monitor (Option 21/24)

This option displays TV (NTSC or PAL) signals (requires Option 08). When used with the AM/FM demodulator (Option 07), audio signals can be monitored simultaneously. With addition of high-speed time domain sweep (Option 04) and the trigger/gate circuit (Option 06), measurement of CATV parameters such as carrier level/frequency, C/N, modulation, distortion, hum and low-frequency interference etc. becomes possible.

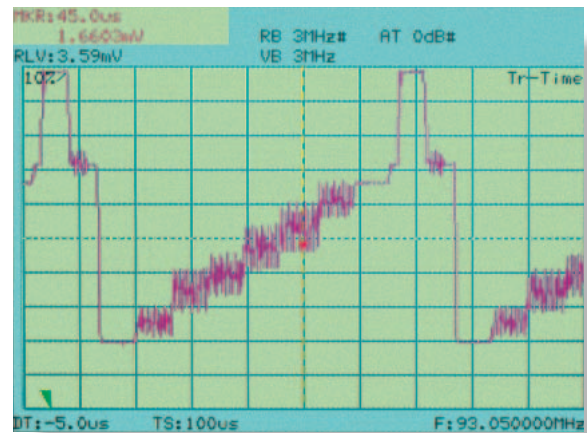

NTSC TV signal waveform

### • EMI measurement

EMI of electronic devices can be measured using the QP detector (Option 12).



# Easy-to-Use Key Layout

## 1 Function keys F1 to F6

Select on-screen menu items

Menu on/off keys turn menus on and off, and [more] key turns menu pages.

## 2 Save/recall

Saves and recalls measurement settings and measured waveforms

Data can be saved either to internal memory or to a memory card.

(Using internal memory, up to 12 data sets can be saved.)

## 3 Main functions

Set frequency, span, amplitude and other parameters

## 4 Markers

Normal markers, multimarkers (maximum 10 numbers), zone markers and zone sweeping are provided.

## 5 Entry keys

Input numeric values, units, and alphabetic characters

## 6 User keys

Register any panel and menu key functions, as well as application software functions to user keys.

## 7 User define key

Define functions of user-defined keys. Up to 3-pages can be predefined.

## 8 Measure key

Executes various operations based on waveform data

High-speed measurements and computations are performed without the need for an external computer.

## 9 Calibration

The built-in high-precision calibration signal source provides accurate measurements.

## 10 Trigger/gate, TV monitor

The trigger can be set in the time domain mode, and analog TV video signals can be monitored.

## 11 Coupled-function keys

Set parameters other than those set using main function keys

Normally set "Auto" for optimum values.

## 12 Display

Can be switched between frequency and time domains, and has two-screen display modes

## 13 Memory card slots

Support memory cards up to 2 Mbytes

Two type-1 memory cards conforming to PCMCIA ver. 2.0 standards can be used simultaneously.

## 14 RF connector

For input of signals at levels up to +30 dBm (maximum DC input:  $\pm 0$  V)

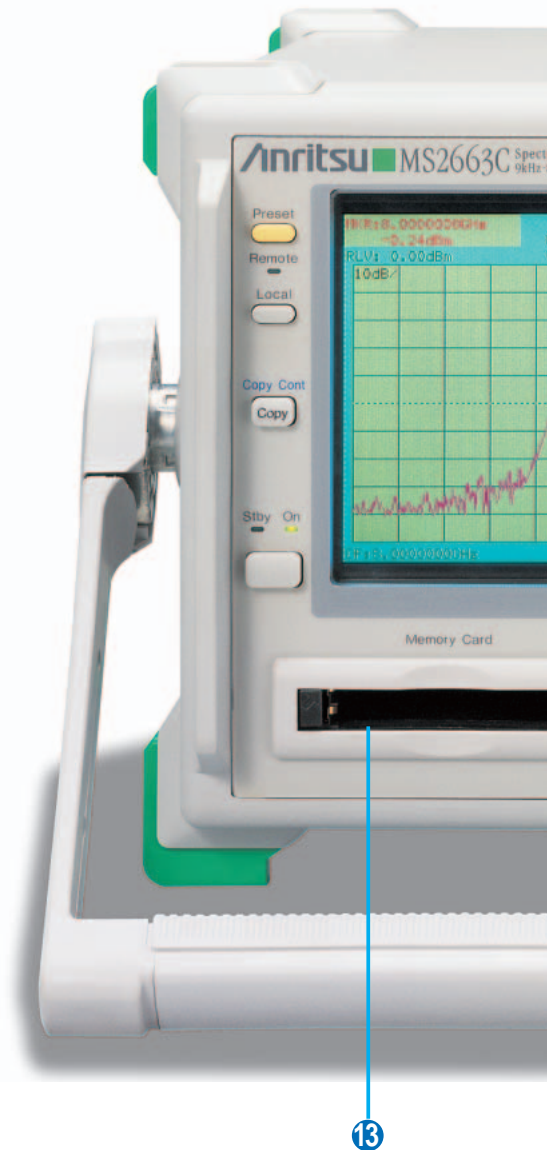

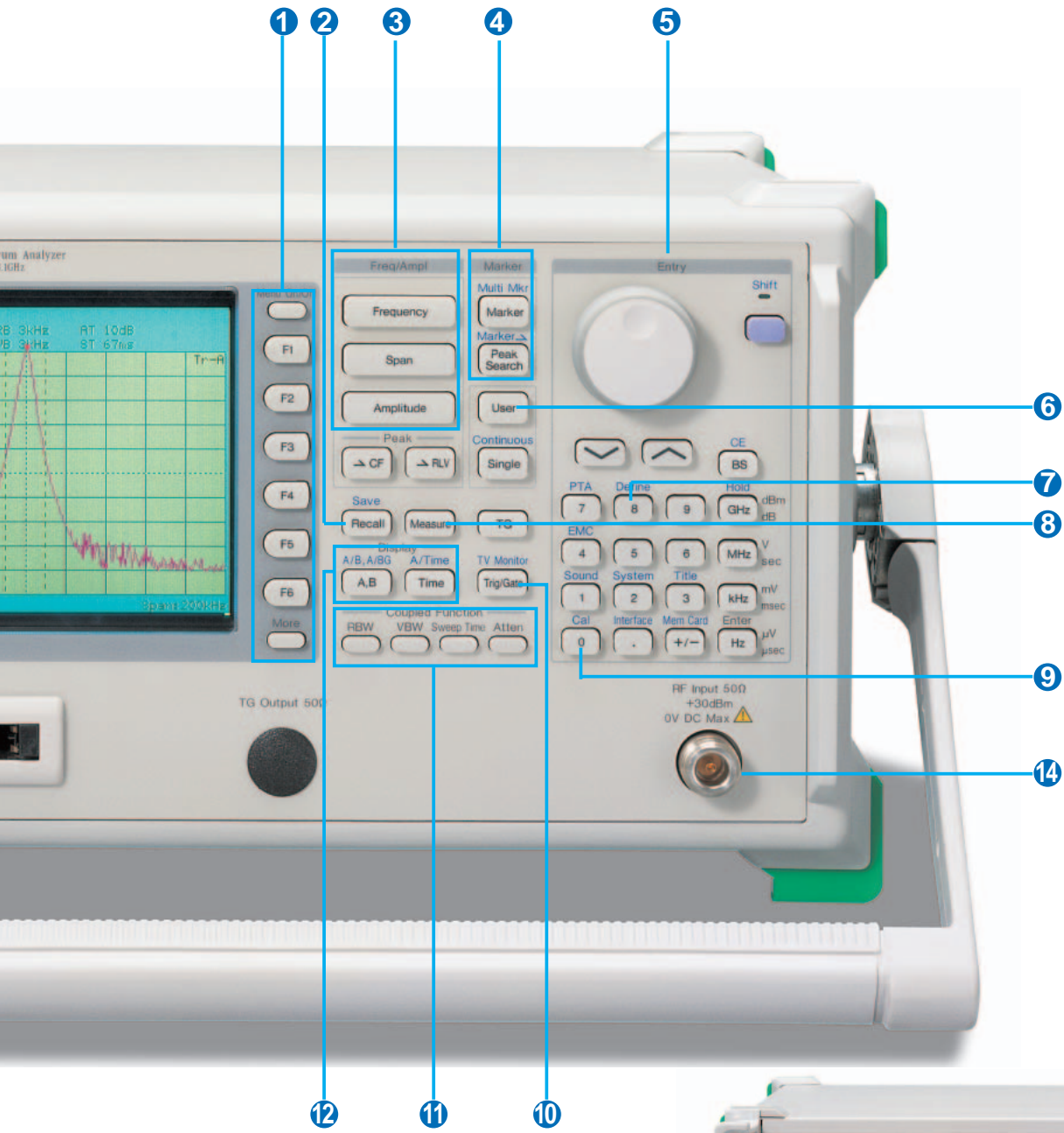

# Configuring Automated Measurement System

- **RS-232C interface (standard)**

The RS-232C interface can be used to output hard copy data to a printer or plotter and for remote control of the analyzer. A notebook computer can be used for automated control and data collection in the field. In addition, a modem can be used for easy remote operation.

- **GPIB interface (standard)**

In addition to remote control, the GPIB interface can also be used to output data to a printer/plotter. (GPIB and Option 10 can not be installed simultaneously.)

- **Centronics interface (Option 10)**

This Centronics interface is installed to output data to a printer. (GPIB and Option 10 can not be installed simultaneously.)

- **Memory card interface (standard)**

Memory cards are used to save and recall measurement settings and waveform data, as well as to upload and download PTA programs. Cards up to 2 Mbytes are supported (PCMCIA ver. 2.0, type-I, 2-slots).

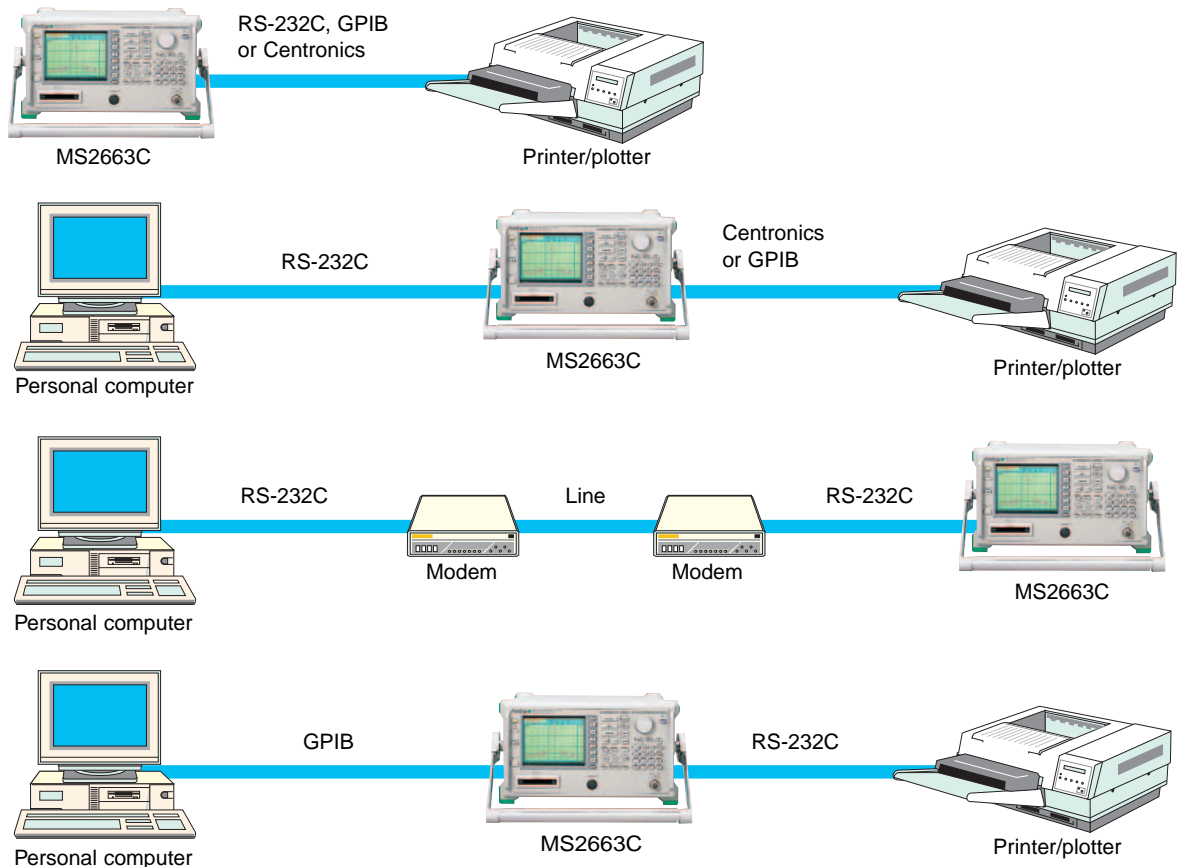



## ● Automated measurement without external controller

The built-in microcomputer (PTA) functions which utilize the spectrum analyzer as a controller, make an external controller unnecessary. An automated measurement system including control of other instruments is easily configured. The two methods for loading programs are shown below.

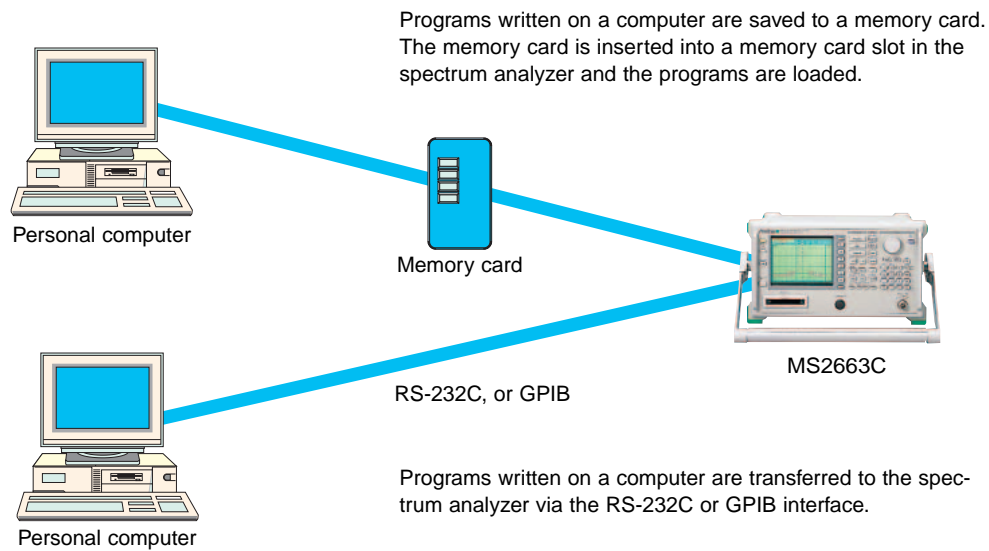

## ● Application software

The following items can be measured automatically using a combination of application software, peripheral equipment and options.

### **MX260002A CDMA Cellular System Measurement Software**

Channel power, occupied frequency bandwidth, adjacent channel power, time response for open-loop power control, spurious

### **MX260003A PDC Measurement Software (for base station)**

Channel power, frequency, occupied frequency bandwidth, adjacent channel power, spurious

### **MX260004A GSM Measurement Software**

Power, time response, adjacent channel power, spurious, intermodulation characteristics

### **MX261001A Low-Power Data Communication System Measurement Software conforming to issue of Direct Spread Spectrum System**

### **MX261002A Low-Power Data Communication System Measurement Software conforming to issue of Frequency Hopping System**

Frequency, power, occupied frequency bandwidth, adjacent channel power, spurious

### **MX262001A CATV Measurement Software**

Video power, C/N, frequency, cross modulation, CTB, modulation factor, hum

### **MX264001A EMI Measurement Software**

Radiated emission, conducted emission

# Specifications

Except where noted otherwise, specified values were obtained after warming up the equipment for 30 minutes at a constant ambient temperature and then performing calibration. The typical values are given for reference, and are not guaranteed.

Frequency	Frequency range	9 kHz to 8.1 GHz
	Frequency band	Band 0 (0 to 3.2 GHz), band 1– (2.92 to 6.5 GHz), band 1+ (6.4 to 8.1 GHz)
	Pre-selector range	2.92 to 8.1 GHz (band 1–, 1+)
	Display frequency accuracy	$\pm$ (display frequency x reference frequency accuracy + span x span accuracy + 100 Hz) *Span: $\geq$ 10 kHz, after calibration
	Marker frequency display accuracy	Normal: Same as display frequency accuracy, Delta: Same as frequency span accuracy
	Frequency counter	Resolution: 1 Hz, 10 Hz, 100 Hz, 1 kHz Accuracy: Display frequency x reference frequency accuracy $\pm$ 1 LSD (at S/N: $\geq$ 20 dB)
	Frequency span	Setting range: 0 Hz, 1 kHz to 8.2 GHz Accuracy: $\pm$ 2.5% (span: $\geq$ 10 kHz), $\pm$ 5% (span: <10 kHz, Option 02 installed)
	Resolution bandwidth (RBW) (3 dB bandwidth)	Setting range: 1 kHz, 3 kHz, 10 kHz, 30 kHz, 100 kHz, 300 kHz, 1 MHz, 3 MHz (manually settable, or automatically settable according to frequency span) *Option 02: 30 Hz, 100 Hz, and 300 Hz are added. Measurements of noise, C/N, adjacent channel power and channel power by measure function are executed with the calculated equivalent noise bandwidth of the RBW. Bandwidth accuracy: $\pm$ 20% (1 kHz to 1 MHz), $\pm$ 30% (3 MHz) Selectivity (60 dB : 3 dB): $\leq$ 15:1
	Video bandwidth (VBW)	1 Hz to 3 MHz (1-3 sequence), OFF *Manually settable, or automatically settable according to RBW
	Noise sideband, stability	Noise sidebands: $\leq$ -100 dBc/Hz (1 GHz, 10 kHz offset) Residual FM: $\leq$ 20 Hzp-p/0.1 s (1 GHz, span: 0 Hz) Frequency drift: $\leq$ 200 Hz/min (span: $\leq$ 10 kHz, sweep time: $\leq$ 100 s) *After 1-hour warm-up at constant ambient temperature
Reference oscillator	Frequency: 10 MHz Aging rate: $2 \times 10^{-6}$ /year (typical); Option 01: $1 \times 10^{-7}$ /year, $2 \times 10^{-8}$ /day Temperature characteristics: $1 \times 10^{-5}$ (typical, 0 to 50°C); Option 01: $\pm 5 \times 10^{-8}$ (0 to 50°C) *Referenced to frequency at 25°C	
Amplitude	Level measurement	Measurement range: Average noise level to +30 dBm Maximum input level: +30 dBm (CW average power, RF ATT: $\geq$ 10 dB), $\pm$ 0 Vdc Average noise level: [Without Option 08] $\leq$ -115 dBm (1 MHz to 1 GHz, band 0), $\leq$ -115 dBm + 1.5f [GHz] dB (1 to 3.1 GHz, band 0), $\leq$ -115 dBm + 0.5f [GHz] dB (2.92 to 8.1 GHz, band 1) *RBW: 1 kHz, VBW: 1 Hz, RF ATT: 0 dB [With Option 08, pre-amplifier: off] $\leq$ 114 dBm (1 MHz to 1 GHz, Band 0), $\leq$ -114 dBm + 1.5 x f [GHz] dB (1 to 3.1 GHz, Band 0), -115 dBm + 0.5 x f [GHz] dB (2.92 to 8.1 GHz, Band 1) Residual response: $\leq$ -100 dBm (RF ATT: 0 dB, input: 50 $\Omega$ terminated, 1 MHz to 8.1 GHz)
	Total level accuracy	$\pm$ 1.3 dB (100 kHz to 3.1 GHz, band 0), $\pm$ 2.3 dB (2.92 to 8.1 GHz, band 1) *Level measurement accuracy after calibration using internal calibration signal Total level accuracy: Reference level accuracy (0 to -49.9 dBm) + frequency response + log linearity (0 to -20 dB) + calibrated signal source accuracy
	Reference level	Setting range Log scale: -100 to +30 dBm, Linear scale: 224 $\mu$ V to 7.07 V Unit Log scale: dBm, dB $\mu$ V, dBmV, V, dB $\mu$ Vemf, W, dB $\mu$ V/m Linear scale: V Reference level accuracy: $\pm$ 0.4 dB (-49.9 to 0 dBm), $\pm$ 0.75 dB (-69.9 to -50 dBm, 0.1 to +30 dBm), $\pm$ 1.5 dB (-80 to -70 dBm) *After calibration, at 100 MHz, span 1 MHz (when RF ATT, RBW, VBW, and sweep time set to AUTO) RBW switching uncertainty: $\pm$ 0.3 dB (1 kHz to 1 MHz), $\pm$ 0.4 dB (3 MHz) *After calibration, referenced to RBW 3 kHz Input attenuator (RF ATT) Setting range: 0 to 70 dB (10 dB steps) *Manual settable, or automatically settable according to reference level Accuracy: $\pm$ 0.3 dB (0 to 50 dB), $\pm$ 1.0 dB (0 to 70 dB) *After calibration, frequency: 100 MHz, referenced to RF ATT: 10 dB
	Frequency response	$\pm$ 0.5 dB (100 kHz to 3.2 GHz, band 0, referenced to 100 MHz, RF ATT: 10 dB, 18 to 28°C) $\pm$ 1.5 dB (9 to 100 kHz, band 0, referenced to 100 MHz, RF ATT: 10 dB, 18 to 28°C) $\pm$ 1.5 dB (2.92 to 8.1 GHz, band 1, referenced to 100 MHz, RF ATT: 10 dB, 18 to 28°C) $\pm$ 1.0 dB (100 kHz to 3.2 GHz, band 0, RF ATT: 10 to 50 dB) $\pm$ 3.0 dB (2.92 to 8.1 GHz, band 1, RF ATT: 10 to 50 dB) *At band 1, after pre-selector tuning

Amplitude	Waveform display	Scale (10 div) Log scale: 10, 5, 2, 1 dB/div Linear scale: 10, 5, 2, 1%/div Linearity (after calibration) Log scale: $\pm 0.4$ dB (0 to $-20$ dB, RBW: $\leq 1$ MHz), $\pm 1.0$ dB (0 to $-70$ dB, RBW: $\leq 100$ kHz), $\pm 1.5$ dB (0 to $-85$ dB, RBW: $\leq 3$ kHz), $\pm 2.5$ dB (0 to $-90$ dB, RBW: $\leq 3$ kHz) Linear scale: $\pm 4\%$ (compared to reference level) Marker level resolution Log scale: 0.01 dB, Linear scale: 0.02% of reference level
	Spurious response	2nd harmonic distortion: $\leq -60$ dBc (10 to 200 MHz, band 0, mixer input: $-30$ dBm), $\leq -75$ dBc (0.2 to 1.3 GHz, band 0, mixer input: $-30$ dBm), $\leq -70$ dBc (1.3 to 1.55 GHz, band 0, mixer input: $-30$ dBm), $\leq -80$ dBc (0.8 to 1 GHz, band 0, mixer input: $-30$ dBm), $\leq -100$ dBc (1.46 to 4.05 GHz, band 1, mixer input: $-20$ dBm) Two signals 3rd order intermodulation distortion: $\leq -70$ dBc (10 to 100 MHz), $\leq -80$ dBc (0.1 to 8.1 GHz) *Frequency difference of two signals: $\geq 50$ kHz, mixer input: $-30$ dBm Image response: $\leq -70$ dBc, Multiple response: $\leq -70$ dBc (band 1)
	1 dB gain compression	$\geq -5$ dBm ( $\geq 100$ MHz, at mixer input level)
	Maximum dynamic range	1 dB gain compression level to average noise level: $> 110$ dB (0.1 to 1 GHz, band 0), $> 110$ dB $-1.5f$ [GHz] dB (1 to 3.1 GHz, band 0), $> 110$ dB $-0.5f$ [GHz] dB (2.92 to 8.1 GHz, band 1) Distortion characteristics (RBW: 1 kHz) 2nd harmonic: $> 72.5$ dB (10 to 200 MHz), $> 80$ dB (200 to 500 MHz), $> 80 - 0.75f$ [GHz] dB (0.5 to 1.3 GHz), $> 82.5 - 0.75f$ [GHz] dB (0.8 to 1 GHz), $> 77.5 - 0.75f$ [GHz] dB (1.3 to 1.55 GHz, band 0), $> 97.5 - 0.25f$ [GHz] dB (1.46 to 4.05 GHz, band 1) 3rd order intermodulation : $> 80$ dB (10 to 100 MHz), $> 83.3$ dB (0.1 to 1 GHz), $> 83.3 - f$ [GHz] dB (1 to 3.1 GHz, band 0), $> 83.3 - (1/3)f$ [GHz] dB (2.92 to 8.1 GHz, band 1)
Sweep	Sweep time	Setting range: 20 ms to 1000 s (manually settable, or automatically settable according to span, RBW, and VBW) Accuracy: $\pm 15\%$ (20 ms to 100 s), $\pm 45\%$ (110 to 1000 s), $\pm 1\%$ (time domain sweep: digital zero span mode)
	Sweep mode	Continuous, single
	Time domain sweep mode	Analog zero span, digital zero span
	Zone sweep	Sweeps only in frequency range indicated by zone marker
	Tracking sweep	Sweeps while tracing peak points within zone marker (zone sweep also possible)
Functions	Number of data points	501
	Detection mode	NORMAL: Simultaneously displays max. and min. points between sample points POS PEAK: Displays max. point between sample points NEG PEAK: Displays min. point between sample points SAMPLE: Displays momentary value at sample points Detection mode switching uncertainty: $\pm 0.5$ dB (at reference level)
	Display	Color TFT-LCD, Size: 5.5", Number of colors: 17 (RGB, each 64-scale settable), Intensity adjustment: 5 steps settable
	Display functions	Trace A: Displays frequency spectrum Trace B: Displays frequency spectrum Trace Time: Displays time domain waveform at center frequency Trace A/B: Displays Trace A and Trace B simultaneously. Simultaneous sweep of same frequency, alternate alternate sweep of independent frequencies Trace A/BG: Displays frequency region to be observed (background) and object band (foreground) selected from background with zone marker simultaneously, alternate sweep Trace A/Time: Displays frequency spectrum, and time domain waveform at center frequency simultaneously, alternate sweep Trace move/calculation: A $\rightarrow$ B, B $\rightarrow$ A, A $\leftrightarrow$ B, A + B $\rightarrow$ A, A - B $\rightarrow$ A, A - B + DL $\rightarrow$ A
	Storage functions	NORMAL, VIEW, MAX HOLD, MIN HOLD, AVERAGE, CUMULATIVE, OVER WRITE
	FM demodulation waveform display function	Demodulation range: 2, 5, 10, 20, 50, 100, 200 kHz/div Marker display Accuracy: $\pm 5\%$ of full scale (referenced to center frequency, DC-coupled. RBW: 3 MHz, VBW: 1 Hz, CW) Demodulation frequency range: DC (50 Hz at AC-coupled) to 100 kHz (range: $\leq 20$ kHz/div, VBW: off, at 3 dB bandwidth) DC (50 Hz at AC-coupled) to 500 kHz (range: $\geq 50$ kHz/div, VBW: off, at 3 dB bandwidth) *RBW: $\geq 1$ kHz usable
Input connector	N-J, 50 $\Omega$	
Auxiliary signal input and output	IF OUTPUT: 10.69 MHz, BNC connector VIDEO OUTPUT (Y): 0 to 0.5 V $\pm 0.1$ V (100 MHz, from lower edge to upper edge at 10 dB/div or 10%/div, 75 $\Omega$ terminated), BNC connector COMPOSITE OUTPUT: For NTSC, 1 Vp-p (75 $\Omega$ terminated), BNC connector EXT REF INPUT: 10 MHz $\pm 10$ Hz, $\geq 0$ dBm (50 $\Omega$ terminated), BNC connector	



Functions	Signal search	AUTO TUNE, PEAK → CF, PEAK → REF, SCROLL
	Zone marker	NORMAL, DELTA
	Marker	MARKER → CF, MARKER → REF, MARKER → CF STEP SIZE, ΔMARKER → SPAN, ZONE → SPAN
	Peak search	PEAK, NEXT PEAK, NEXT RIGHT PEAK, NEXT LEFT PEAK, MIN DIP, NEXT DIP
	Multimarker	Number of markers: 10 max. (HIGHEST 10, HARMONICS, MANUAL SET)
	Measure	Noise power (dBm/Hz, dBm/ch), C/N (dBc/Hz, dBc/ch), occupied bandwidth (power N% method, X-dB down method), adjacent channel power (REF: total power/reference level/in-band level method, channel designate display: 2 channels x 2 graphic display), average power of burst signal (average power in designated time range of time domain waveform), channel power (dBm, dBm/Hz), template comparison (upper/lower limits x each 2, time domain), MASK (upper/lower x each 2, frequency domain)
	Save/recall	Save and recall setting conditions and waveform data to internal memory (max.12) or memory card
	Hard copy	Printer (HP dotmatrix, EPSON dotmatrix compatible models): Display data can be hard-copied via RS-232C, GPIB and Centronics (Option 10) interface Plotter (HP-GL, GP-GL compatible models): Display data can be output via RS-232C, and GPIB interface
	PTA	Language: PTL (interpreter based on BASIC) Programming: Using external computer Program memory: Memory card, upload/download to/from external computer Programming capacity: 192 KB Data processing: Directly accesses measurement data according to system variables, system subroutines, and system functions
	RS-232C	Outputs data to printer and plotter. Control from external computer (excluding power switch)
GPIB	Meets IEEE488.2. Controlled by external computer (excluding power switch). Or controls external equipment with PTA Interface function: SH1, AH1, T6, L4, SR1, RL1, PP0, DC1, DT1, C1, C2, C3, C4, C28	
Correction	Automatic correction of insertion loss of MA1621A Impedance Transformer Correction accuracy (RF ATT: ≥10 dB): ±2.5 dB (9 to 100 kHz), ±1.5 dB (100 kHz to 2 GHz), ±2.0 dB (2 to 3 GHz, typical) Antenna correction coefficients: Correct display and measurement of field strengths (dBμV/m) for specified antennas Internal antenna correction coefficients (MP534A/651A Dipole Antenna, MP635A/666A Log-Periodic Antenna, MP414B Loop Antenna, and four antennas user-defined; write via GPIB or RS-232C, save/load to/from memory card)	
Memory card interface	Functions: Saving/recalling measurement parameters/waveform data, uploading/downloading PTA programs; Applicable cards: SRAM, EPROM, Flash EPROM *Only SRAM writable; Card capacity: 2 MB max. Connector: Meets the JEIDA Ver. 4/4.1, PCMCIA Rel. 2.0; 2 slots	
Others	EMC	EN61326: 1997/A2: 2001 (Class A) EN61000-3-2: 2000 (Class A) EN61326: 1997/A2: 2001 (Annex A)
	LVD	EN61010-1: 2001 (Pollution Degree 2)
	Vibration	Meets the MIL-STD-810D
	Power (operating range)	85 to 132/170 to 250 Vac (automatic voltage switching), 47.5 to 63 Hz, 380 to 420 Hz (85 to 132 V only), ≤330 VA
	Dimensions and mass	320 (W) x 177 (H) x 351 (D) mm, ≤13.5 kg (without option)
	Ambient temperature	0 to +50°C (operate), -40 to +75°C (storage)

### ● Option 01: Reference crystal oscillator

Frequency	10 MHz
Aging rate	≤1 x 10 <sup>-7</sup> /year, ≤2 x 10 <sup>-9</sup> /day (after power on, with reference to frequency after 24 h)
Temperature characteristics	±5 x 10 <sup>-8</sup> (0 to 50°C, with reference to 25°C)
Buffer output	10 MHz, >2 Vp-p (200 Ω termination), BNC connector

### ● Option 02: Narrow resolution bandwidth

Resolution bandwidth (3 dB)	30 Hz, 100 Hz, 300 Hz
Resolution bandwidth switching uncertainty	±0.4 dB (RBW 3 kHz referenced)
Resolution bandwidth accuracy	±20% (100, 300 Hz)
Selectivity (60 dB:3 dB)	≤15:1 (RBW: 100, 300 Hz), ≤20:1 (RBW: 30 Hz)

## ● Option 04: High-speed time domain sweep

Sweep time	12.5 $\mu$ s, 25 $\mu$ s, 50 $\mu$ s, 100 to 900 $\mu$ s (one most significant digit settable), 1.0 to 19 ms (two upper significant digits settable)
Accuracy	$\pm$ 1%
Marker level resolution	0.1 dB (log scale), 0.2% (linear scale, relative to reference level)

## ● Option 06: Trigger/gate circuit

Trigger switch	FREERUN, TRIGGERED	
Trigger source	EXT	Trigger level: $\pm$ 10 V (resolution: 0.1 V), TTL level Trigger slope: Rise, fall Connector: BNC
	VIDEO	Log scale: $-100$ to $0$ dB (resolution: 1 dB) Trigger slope: Rise, fall
	WIDE IF VIDEO	Trigger level: High, middle, or low selectable Bandwidth: $\geq$ 20 MHz Trigger slope: Rise, fall
	LINE	Frequency: 47.5 to 63 Hz (line lock)
	TV	Method: M-NTSC, B/G/H PAL Sync: V-SYNC, H-SYNC Sync line (NTSC) H-SYNC (ODD): 7 to 262 line, H-SYNC (EVEN): 1 to 263 line Sync line (PAL) H-SYNC (ODD): 1 to 312 line, H-SYNC (EVEN): 317 to 625 line *Option 16 required
Trigger delay	Pre-trigger (displays waveform from previous max. 1 screen at trigger occurrence point) Range: $-$ time span to 0 s, Resolution: time span/500 Post trigger (displays waveform from after max. 65.5 ms at trigger occurrence point) Range: 0 to 65.5 ms, Resolution: 1 $\mu$ s	
Gate sweep	In frequency domain, displays spectrum of input signal in specified gate interval Gate delay: 0 to 65.5 ms (from trigger point, resolution: 1 $\mu$ s) Gate width: 2 $\mu$ s to 65.5 ms (from gate delay, resolution: 1 $\mu$ s)	

## ● Option 08: Pre-amplifier\*<sup>1</sup>\*<sup>3</sup>

Frequency range	100 kHz to 3 GHz	
Noise figure	$\leq$ 8 dB (typical, $<$ 2 GHz), $\leq$ 13 dB (typical, $\geq$ 2 GHz)	
Amplitude	Measurement range	Average noise level to +10 dBm
	Max. input level	CW average power: +10 dBm, $\pm$ 0 Vdc
	Average noise level	$\leq$ -132 dBm (1 MHz to 1 GHz), $\leq$ -132 dBm + 2f [GHz] dB ( $>$ 1 GHz) *RBW: 1 kHz, VBW: 1 Hz, RF ATT: 0 dB
	Reference level	Setting range Log scale: $-120$ to +10 dBm, or equivalent level Linear scale: 22.4 $\mu$ V to 707 mV Reference level accuracy: $\pm$ 0.5 dB ( $-69.9$ to $-20$ dBm), $\pm$ 0.75 dB ( $-89.9$ to $-70$ dBm, $-19.9$ to +10 dBm) *After calibration, referenced to 100 MHz, span: 1 MHz (RF ATT, RBW, VBW and sweep time set to AUTO) RBW switching uncertainty: $\pm$ 0.5 dB *After calibration, referenced to RBW: 3 kHz RF ATT switching uncertainty: $\pm$ 0.5 dB (0 to 50 dB), $\pm$ 1.0 dB (0 to 70 dB) *After calibration, referenced to 100 MHz, RF ATT: 10 dB
	Frequency response	$\pm$ 2.0 dB (100 kHz to 3 GHz, referenced to 100 MHz, RF ATT: 10 to 50 dB)
	Linearity of waveform display	Log scale (after calibration): $\pm$ 0.5 dB (0 to $-20$ dB), $\pm$ 1.0 dB (0 to $-60$ dB), $\pm$ 1.5 dB (0 to $-75$ dB) Linear scale (after calibration): $\pm$ 5% (according to reference level)
	Spurious response	Two signals 3rd order intermodulation distortion: $\leq$ -70 dBc (10 MHz to 3 GHz) *Frequency difference of two signals: $\geq$ 50 kHz, pre-amplifier input* <sup>2</sup> : $-55$ dBm
	1 dB gain compression	$\geq$ -35 dBm ( $\geq$ 100 MHz, at pre-amplifier input level* <sup>2</sup> )

\*1: Overall specification with pre-amplifier on (Noise figure is the simple performance.)

\*2: Pre-amplifier input level = RF input level – RF ATT setting level

\*3: Option 20 can not be installed simultaneously.

## ● Option 07: AM/FM demodulator

Voice output	With internal loudspeaker and earphone connector (Ø3.5 jack), adjustable volume
--------------	---

## ● Option 10: Centronics interface\*1

Function	Outputs data to printer (Centronics standard)
Connector	D-sub 25-pin (jack)

\*1: GPIB interface can not be installed simultaneously.

## ● Option 12: QP detector

Functions	QP detection *Requires Option 02																																											
6 dB bandwidth	200 Hz, 9 kHz, 120 kHz Accuracy: $\pm 30\%$ (18 to 28°C)																																											
Display	LOG scale, 5 dB/div (10 divisions) Linearity: $\leq \pm 2.0$ dB (0 to -40 dB, CW signal, reference level: 60 dB $\mu$ V, RF ATT: 0 dB, 18 to 28°C)																																											
Pulse response characteristics	Response to CISPR pulse (DET mode: QP, 18 to 28°C)																																											
	<table border="1"> <thead> <tr> <th rowspan="2">Repetition frequency</th> <th colspan="3">Bandwidth</th> </tr> <tr> <th>120 kHz</th> <th>9 kHz</th> <th>200 Hz</th> </tr> </thead> <tbody> <tr> <td>1 kHz</td> <td><math>\leq -8.0 \pm 1.0</math> dB</td> <td><math>\leq -4.5 \pm 1.0</math> dB</td> <td>—</td> </tr> <tr> <td>100 Hz</td> <td>Referenced</td> <td>Referenced</td> <td><math>\leq -4.0 \pm 1.0</math> dB</td> </tr> <tr> <td>60 Hz</td> <td>—</td> <td>—</td> <td><math>\leq -3.0 \pm 1.0</math> dB</td> </tr> <tr> <td>25 Hz</td> <td>—</td> <td>—</td> <td>Referenced</td> </tr> <tr> <td>20 Hz</td> <td><math>\leq +9.0 \pm 1.0</math> dB</td> <td><math>\leq +6.5 \pm 1.0</math> dB</td> <td>—</td> </tr> <tr> <td>10 Hz</td> <td><math>\leq +14.0 \pm 1.5</math> dB</td> <td><math>\leq +10.0 \pm 1.5</math> dB</td> <td><math>\leq +4.0 \pm 1.0</math> dB</td> </tr> <tr> <td>5 Hz</td> <td>—</td> <td>—</td> <td><math>\leq +7.5 \pm 1.5</math> dB</td> </tr> <tr> <td>2 Hz</td> <td><math>\leq +26.0 \pm 2.0</math> dB</td> <td><math>\leq +20.5 \pm 2.0</math> dB</td> <td><math>\leq +13.0 \pm 2.0</math> dB</td> </tr> <tr> <td>1 Hz</td> <td><math>\leq +28.5 \pm 2.0</math> dB</td> <td><math>\leq +22.5 \pm 2.0</math> dB</td> <td><math>\leq +17.0 \pm 2.0</math> dB</td> </tr> </tbody> </table>	Repetition frequency	Bandwidth			120 kHz	9 kHz	200 Hz	1 kHz	$\leq -8.0 \pm 1.0$ dB	$\leq -4.5 \pm 1.0$ dB	—	100 Hz	Referenced	Referenced	$\leq -4.0 \pm 1.0$ dB	60 Hz	—	—	$\leq -3.0 \pm 1.0$ dB	25 Hz	—	—	Referenced	20 Hz	$\leq +9.0 \pm 1.0$ dB	$\leq +6.5 \pm 1.0$ dB	—	10 Hz	$\leq +14.0 \pm 1.5$ dB	$\leq +10.0 \pm 1.5$ dB	$\leq +4.0 \pm 1.0$ dB	5 Hz	—	—	$\leq +7.5 \pm 1.5$ dB	2 Hz	$\leq +26.0 \pm 2.0$ dB	$\leq +20.5 \pm 2.0$ dB	$\leq +13.0 \pm 2.0$ dB	1 Hz	$\leq +28.5 \pm 2.0$ dB	$\leq +22.5 \pm 2.0$ dB	$\leq +17.0 \pm 2.0$ dB
	Repetition frequency		Bandwidth																																									
		120 kHz	9 kHz	200 Hz																																								
	1 kHz	$\leq -8.0 \pm 1.0$ dB	$\leq -4.5 \pm 1.0$ dB	—																																								
	100 Hz	Referenced	Referenced	$\leq -4.0 \pm 1.0$ dB																																								
	60 Hz	—	—	$\leq -3.0 \pm 1.0$ dB																																								
	25 Hz	—	—	Referenced																																								
	20 Hz	$\leq +9.0 \pm 1.0$ dB	$\leq +6.5 \pm 1.0$ dB	—																																								
	10 Hz	$\leq +14.0 \pm 1.5$ dB	$\leq +10.0 \pm 1.5$ dB	$\leq +4.0 \pm 1.0$ dB																																								
5 Hz	—	—	$\leq +7.5 \pm 1.5$ dB																																									
2 Hz	$\leq +26.0 \pm 2.0$ dB	$\leq +20.5 \pm 2.0$ dB	$\leq +13.0 \pm 2.0$ dB																																									
1 Hz	$\leq +28.5 \pm 2.0$ dB	$\leq +22.5 \pm 2.0$ dB	$\leq +17.0 \pm 2.0$ dB																																									
QP on/off switching uncertainty (PEAK, QP)	$\leq \pm 1.0$ dB (CW signal, reference level - 40 dB, after auto-calibration, 18 to 28°C)																																											
Detection mode	QP, AVERAGE																																											
Field strength measurement	Waveform data compensation data display for specified antenna factor, field strength (dB $\mu$ V/m) Built-in antenna factors: MP534A/651A Dipole Antenna, MP635A/666A Log-Periodic Antenna, MP414B Loop Antenna, user-defined (four types writable via GPIB or RS-232C, can be saved/loaded to/from memory card)																																											

## ● Option 21: Television monitor (Multi)\*1

Video	M-NTSC, B/G/H/I/D PAL, color
Audio	Simultaneous monitoring of video and audio *Needs Option 07
Functions	Channel: Automatic setting to broadcast wave of CCIR, Japan, USA, Italy, UK and China Automatic setting to CATV of CCIR, Japan, and USA Trigger: Triggered sweep by V-SYNC, H-SYNC *Needs trigger/gate circuit (Option 6) Aux. output: Composite video signal (connector: BNC)

\*1: Requires Option 08

## ● Option 24: Television monitor (Brazil)\*1

Video	M-NTSC, M PAL, color
Audio	Simultaneous monitoring of video and audio *Needs Option 07
Functions	Channel: Automatic setting to broadcast wave of CCIR, Japan and USA Automatic setting to CATV of CCIR, Japan and USA Trigger: Triggered sweep by V-SYNC, H-SYNC *Needs trigger/gate circuit (Option 06) Aux. output: Composite video signal, Connector: BNC

\*1: Requires Option 08

## ● Option 15: Sweep signal output

Sweep output (X)	0 to 10 V $\pm 1V$ ( $\geq 100$ k $\Omega$ termination, from left side to right side of display scale), BNC connector
Sweep status output (Z)	TTL level (low level with sweeping), BNC connector

## ● Option 14: PTA parallel I/O

Functions	Controls external devices from PTA, cannot be installed when Option 10 installed																																																																												
System variables	As follows using PTA system variables IOA: Controls 8-bit parallel output port A IOB: Controls 8-bit parallel output port B IOC: Controls 4-bit parallel input/output port C IOD: Controls 4-bit parallel input/output port D EIO: Controls I/O switching of ports C/D EXO: Controls I/O trigger																																																																												
PTL statements	External interrupt control of input to I/O ports using PTA-PTL statements IOEN statement: Enables interrupt input IODI statement: Disables interrupt input IOMA statement: Masks interrupt input ON TO GOTO statement: Changes program flow at interrupt generation ON TO GOSUB statement: Changes program flow at interrupt generation																																																																												
Write strobe signal	Write strobe signal (negative pulse) output externally at control of output ports C/D																																																																												
Power supply	External +5 ±0.5 Vdc (max. 100 mA) supply																																																																												
Signal logic levels	Negative logic, TTL level Specified current: Output ports A/B (max. output current Hi: 2.6 mA, Lo: 24 mA) Output ports C/D (max. output current Hi: 15 mA, Lo: 24 mA) Other control output lines (max. output current Hi: 0.4 mA, Lo: 8 mA)																																																																												
Connection cable connectors	Amphenol 36 pins																																																																												
Connector pin layout	<table border="1"> <thead> <tr> <th>No.</th> <th>Item</th> <th>No.</th> <th>Item</th> </tr> </thead> <tbody> <tr><td>1</td><td>GND</td><td>19</td><td>Output port B (6)</td></tr> <tr><td>2</td><td>Trigger input</td><td>20</td><td>Output port B (7) MSB</td></tr> <tr><td>3</td><td>Trigger output 1</td><td>21</td><td>I/O port C (0) LSB</td></tr> <tr><td>4</td><td>Trigger output 2</td><td>22</td><td>I/O port C (1)</td></tr> <tr><td>5</td><td>Output port A (0) LSB</td><td>23</td><td>I/O port C (2)</td></tr> <tr><td>6</td><td>Output port A (1)</td><td>24</td><td>I/O port C (3) MSB</td></tr> <tr><td>7</td><td>Output port A (2)</td><td>25</td><td>I/O port D (0) LSB</td></tr> <tr><td>8</td><td>Output port A (3)</td><td>26</td><td>I/O port D (1)</td></tr> <tr><td>9</td><td>Output port A (4)</td><td>27</td><td>I/O port D (2)</td></tr> <tr><td>10</td><td>Output port A (5)</td><td>28</td><td>I/O port D (3) MSB</td></tr> <tr><td>11</td><td>Output port A (6)</td><td>29</td><td>Port C status 0/1: I/O</td></tr> <tr><td>12</td><td>Output port A (7) MSB</td><td>30</td><td>Port D status 0/1: I/O</td></tr> <tr><td>13</td><td>Output port B (0) LSB</td><td>31</td><td>Write strobe signal</td></tr> <tr><td>14</td><td>Output port B (1)</td><td>32</td><td>Interruption signal</td></tr> <tr><td>15</td><td>Output port B (2)</td><td>33</td><td>Not used</td></tr> <tr><td>16</td><td>Output port B (3)</td><td>34</td><td>+5 V power supply</td></tr> <tr><td>17</td><td>Output port B (4)</td><td>35</td><td>Not used</td></tr> <tr><td>18</td><td>Output port B (5)</td><td>36</td><td>Not used</td></tr> </tbody> </table>	No.	Item	No.	Item	1	GND	19	Output port B (6)	2	Trigger input	20	Output port B (7) MSB	3	Trigger output 1	21	I/O port C (0) LSB	4	Trigger output 2	22	I/O port C (1)	5	Output port A (0) LSB	23	I/O port C (2)	6	Output port A (1)	24	I/O port C (3) MSB	7	Output port A (2)	25	I/O port D (0) LSB	8	Output port A (3)	26	I/O port D (1)	9	Output port A (4)	27	I/O port D (2)	10	Output port A (5)	28	I/O port D (3) MSB	11	Output port A (6)	29	Port C status 0/1: I/O	12	Output port A (7) MSB	30	Port D status 0/1: I/O	13	Output port B (0) LSB	31	Write strobe signal	14	Output port B (1)	32	Interruption signal	15	Output port B (2)	33	Not used	16	Output port B (3)	34	+5 V power supply	17	Output port B (4)	35	Not used	18	Output port B (5)	36	Not used
No.	Item	No.	Item																																																																										
1	GND	19	Output port B (6)																																																																										
2	Trigger input	20	Output port B (7) MSB																																																																										
3	Trigger output 1	21	I/O port C (0) LSB																																																																										
4	Trigger output 2	22	I/O port C (1)																																																																										
5	Output port A (0) LSB	23	I/O port C (2)																																																																										
6	Output port A (1)	24	I/O port C (3) MSB																																																																										
7	Output port A (2)	25	I/O port D (0) LSB																																																																										
8	Output port A (3)	26	I/O port D (1)																																																																										
9	Output port A (4)	27	I/O port D (2)																																																																										
10	Output port A (5)	28	I/O port D (3) MSB																																																																										
11	Output port A (6)	29	Port C status 0/1: I/O																																																																										
12	Output port A (7) MSB	30	Port D status 0/1: I/O																																																																										
13	Output port B (0) LSB	31	Write strobe signal																																																																										
14	Output port B (1)	32	Interruption signal																																																																										
15	Output port B (2)	33	Not used																																																																										
16	Output port B (3)	34	+5 V power supply																																																																										
17	Output port B (4)	35	Not used																																																																										
18	Output port B (5)	36	Not used																																																																										

## ● Option 20: Tracking generator\*1

Frequency range	9 kHz to 3 GHz
Output level range	0 to -60 dBm
Setting resolution	0.1 dB
Output level accuracy	±1.0 dB (at 100 MHz, 0 dBm)
Output level flatness	±1.5 dB (100 kHz to 3 GHz, output level: 0 dBm, referenced to 100 MHz frequency)
Output level linearity	±1.0 dB (0 to -30 dBm), ±2.0 (-30 to -60 dBm) *100 kHz to 3 GHz, 0 dBm output level reference
Spurious	Harmonic: ≤-15 dBc (9 to 100 kHz), ≤-20 dBc (100 kHz to 3 GHz), Non-harmonic: ≤-15 dBc (9 to 100 kHz), ≤-35 dBc (100 kHz to 2 GHz), ≤-30 dBc (2 to 3 GHz)
Tracking generator feed through	≤-95 dBm (spectrum analyzer input and tracking generator output connectors terminated at 50 Ω)
Output connector	N-J, 50 Ω

\*1: Option 08 can not be installed simultaneously.



# Ordering Information

Please specify model/order number, name and quantity when ordering.

Model/order No.	Name	Remarks
MS2663C	<b>Main frame</b> Spectrum Analyzer	
	<b>Standard accessories</b>	
	Power cord, 2.6 m: 1 pc	
F0013	Fuse, 5 A: 2 pcs	
W1251AE	MS2650B,MS2660B/C series operation manual:1 copy	
B0329G	Front cover	3/4MW4U
	<b>Options</b>	
MS2663C-01	Reference crystal oscillator	Stability: $\leq 2 \times 10^{-9}$ /day
MS2663C-02	Narrow resolution bandwidth	30/100/300 Hz
MS2663C-04	High-speed time domain sweep	1.25 $\mu$ s/div
MS2663C-06	Trigger/gate circuit	Pre-trigger and post trigger available
MS2663C-07	AM/FM demodulator	Outputs to loudspeaker or earphone connector
MS2663C-08	Pre-amplifier	100 kHz to 3 GHz, Option 20 can not be installed simultaneously.
MS2663C-10	Centronics interface	GPIB cannot be installed simultaneously.
MS2663C-12	QP detector	Requires Option 02 (QP-BW: 0.2, 9, 120 kHz)
MS2663C-14	PTA parallel I/O	Option 10 cannot be installed simultaneously.
MS2663C-15	Sweep signal output	X, Z
MS2663C-20	Tracking generator	9 kHz to 3 GHz, Option 08 can not be installed simultaneously.
MS2663C-21	Television monitor (Multi)	M-NTSC, B/G/H/I/D PAL (Requires Option 08)
MS2663C-24	Television monitor (Brazil)	M-NTSC, M PAL (Requires Option 08)
	<b>Warranty</b>	
MS2663C-90	Extended three year warranty service	
MS2663C-91	Extended five year warranty service	
	<b>Measurement software</b>	
MX260002A	CDMA Cellular System Measurement Software	
MX260003A	PDC Measurement Software (for base station)	
MX260004A	GSM Measurement Software	
MX261001A	Low-Power Data Communication System Measurement Software conforming to issue of Direct Spread Spectrum System	
MX261002A	Low-Power Data Communication System Measurement Software conforming to issue of Frequency Hopping System	
MX262001A	CATV Measurement Software	
MX264001A	EMI Measurement Software	
	<b>Application parts</b>	
J0561	Coaxial cord (N-P-5W-5D-2W-N-P-5W), 1 m	
J0104A	Coaxial cord (BNC-P-RG-55/U-N-P) , 1 m	
CSCJ-256K-SM	256 KB memory card	Meets PCMCIA Rel. 2.0
CSCJ-512K-SM	512 KB memory card	Meets PCMCIA Rel. 2.0
CSCJ-001M-SM	1024 KB memory card	Meets PCMCIA Rel. 2.0
CSCJ-002M-SM	2048 KB memory card	Meets PCMCIA Rel. 2.0
B0395A	Rack mount kit (IEC)	
B0395B	Rack mount kit (JIS)	
J0055	Coaxial adaptor (NC-P-BNC-J)	
J0076	Coaxial adaptor (NC-P-F-J)	
B0391A	Carrying case (hard type)	With casters
B0391B	Carrying case (hard type)	Without casters
MP612A	RF Fuse Holder	DC to 1000 MHz, 50 $\Omega$ (N)
MP613A	Fuse Element	For MP612A
J0805	DC block (Model 7003)	10 kHz to 18 GHz, $\pm 50$ V, Weinschel product

Model/order No.	Name	Remarks
MA2507A	DC Block Adaptor	50 $\Omega$ , 9 kHz to 3 GHz, $\pm 50$ V
MA8601A	DC Block Adaptor	50 $\Omega$ , 30 kHz to 2 GHz, $\pm 50$ V
MA8601J	DC Block Adaptor	75 $\Omega$ , 10 kHz to 2.2 GHz, $\pm 50$ V
MA1621A	50 $\Omega$ $\rightarrow$ 75 $\Omega$ Impedance Transformer	9 kHz to 3 GHz, $\pm 100$ V
MP614B	50 $\Omega$ $\leftrightarrow$ 75 $\Omega$ Impedance Transformer	50 to 1200 MHz (transformer type)
J0121	Coaxial cord (NC-P-3W-3C-2WS-NC-P-3W), 1 m	
J0308	Coaxial cord (BNC-P-3C-2WS-NC-P-3W), 1 m	
J0063	Fixed attenuator for high power	30 dB (10 W, DC to 12.4 GHz)
J0395	Fixed attenuator for high power	30 dB (30 W, DC to 9 GHz)
MP640A	Branch	40 dB, DC to 1700 MHz
MP654A	Branch	30 dB, 0.8 to 3 GHz
MP520A	CM Directional Coupler	25 to 500 MHz, 75 $\Omega$ (NC)
MP520B	CM Directional Coupler	25 to 1000 MHz, 75 $\Omega$ (NC)
MP520C	CM Directional Coupler	25 to 500 MHz, 50 $\Omega$ (N)
MP520D	CM Directional Coupler	100 to 1700 MHz, 50 $\Omega$ (N)
MP526A	High Pass Filter	60 MHz band
MP526B	High Pass Filter	150 MHz band
MP526C	High Pass Filter	250 MHz band
MP526D	High Pass Filter	400 MHz band
MP526G	High Pass Filter	27 MHz band
MA1601A	High Pass Filter	800/900 MHz band, N
J0007	GPIB cable, 1 m	408JE-101
J0008	GPIB cable, 2 m	408JE-102
J0742A	RS-232C cable, 1 m	For PC-98 Personal Computer and VP-600, D-sub 25 pins (straight)
J0743A	RS-232C cable, 1 m	For PC/AT compatible, D-sub 9-pins (cross)
MH648A	Pre-Amplifier	100 kHz to 1200 MHz
MP534A	Dipole Antenna	25 to 520 MHz
MP651A	Dipole Antenna	470 to 1700 MHz
BBA9106/VHA9103	Biconical Antenna	30 to 300 MHz
MP635A	Log-Periodic Antenna	80 to 1000 MHz
MP666A	Log-Periodic Antenna	200 to 2000 MHz
MB9A	Tripod	For MP534A/B, MP651A/B
MB19A	Tripod	For MP635A/666A
MA2601B	EMI Probe	
MA2601C	EMI Probe	
KT-10	EMI clamp	
KT-20	EMI clamp	



Specifications are subject to change without notice.

#### **ANRITSU CORPORATION**

1800 Onna, Atsugi-shi, Kanagawa, 243-8555 Japan  
Phone: +81-46-223-1111  
Fax: +81-46-296-1264

#### ● **U.S.A.** **ANRITSU COMPANY** **TX OFFICE SALES AND SERVICE**

1155 East Collins Blvd., Richardson, TX 75081, U.S.A.  
Toll Free: 1-800-ANRITSU (267-4878)  
Phone: +1-972-644-1777  
Fax: +1-972-644-3416

#### ● **Canada** **ANRITSU ELECTRONICS LTD.**

700 Silver Seven Road, Suite 120, Kanata,  
ON K2V 1C3, Canada  
Phone: +1-613-591-2003  
Fax: +1-613-591-1006

#### ● **Brasil** **ANRITSU ELETRÔNICA LTDA.**

Praca Amadeu Amaral, 27 - 1 andar  
01327-010 - Paraiso, Sao Paulo, Brazil  
Phone: +55-11-3283-2511  
Fax: +55-11-3886940

#### ● **U.K.** **ANRITSU LTD.** 200 Capability Green, Luton, Bedfordshire LU1 3LU, U.K. Phone: +44-1582-433280 Fax: +44-1582-731303

#### ● **Germany** **ANRITSU GmbH** Grafenberger Allee 54-56, 40237 Düsseldorf, Germany Phone: +49-211-96855-0 Fax: +49-211-96855-55

#### ● **France** **ANRITSU S.A.** 9, Avenue du Québec Z.A. de Courtabœuf 91951 Les Ulis Cedex, France Phone: +33-1-60-92-15-50 Fax: +33-1-64-46-10-65

#### ● **Italy** **ANRITSU S.p.A.** Via Elio Vittorini, 129, 00144 Roma EUR, Italy Phone: +39-06-509-9711 Fax: +39-06-502-2425

#### ● **Sweden** **ANRITSU AB** Borgafjordsgatan 13 164 40 Kista, Sweden Phone: +46-853470700 Fax: +46-853470730

#### ● **Finland** **ANRITSU AB** Teknobulevardi 3-5, FI-01530 Vantaa, Finland Phone: +358-9-4355-220 Fax: +358-9-4355-2250

#### ● **Denmark** **Anritsu AB Danmark** Korskildelund 6 DK - 2670 Greve, Denmark Phone: +45-36915035 Fax: +45-43909371

#### ● **Singapore** **ANRITSU PTE LTD.** 10, Hoe Chiang Road #07-01/02, Keppel Towers, Singapore 089315 Phone: +65-6282-2400 Fax: +65-6282-2533

#### ● **Hong Kong** **ANRITSU COMPANY LTD.** Suite 923, 9/F., Chinachem Golden Plaza, 77 Mody Road, Tsimshatsui East, Kowloon, Hong Kong, China Phone: +852-2301-4980 Fax: +852-2301-3545

#### ● **P. R. China** **ANRITSU COMPANY LTD.** **Beijing Representative Office** Room 1515, Beijing Fortune Building, No. 5 North Road, the East 3rd Ring Road, Chao-Yang District Beijing 100004, P.R. China Phone: +86-10-6590-9230

#### ● **Korea** **ANRITSU CORPORATION** 8F Hyun Juk Bldg. 832-41, Yeoksam-dong, Kangnam-ku, Seoul, 135-080, Korea Phone: +82-2-553-6603 Fax: +82-2-553-6604

#### ● **Australia** **ANRITSU PTY LTD.** Unit 3/170 Forster Road Mt. Waverley, Victoria, 3149, Australia Phone: +61-3-9558-8177 Fax: +61-3-9558-8255

#### ● **Taiwan** **ANRITSU COMPANY INC.** 7F, No. 316, Sec. 1, NeiHu Rd., Taipei, Taiwan Phone: +886-2-8751-1816 Fax: +886-2-8751-1817

050203