

# Keysight Technologies

## Bench and System Switching Products

### Selection Guide



# Choose Keysight for Confidence in your Switching and Measurements

Keysight system and bench instruments surrounding your DUT

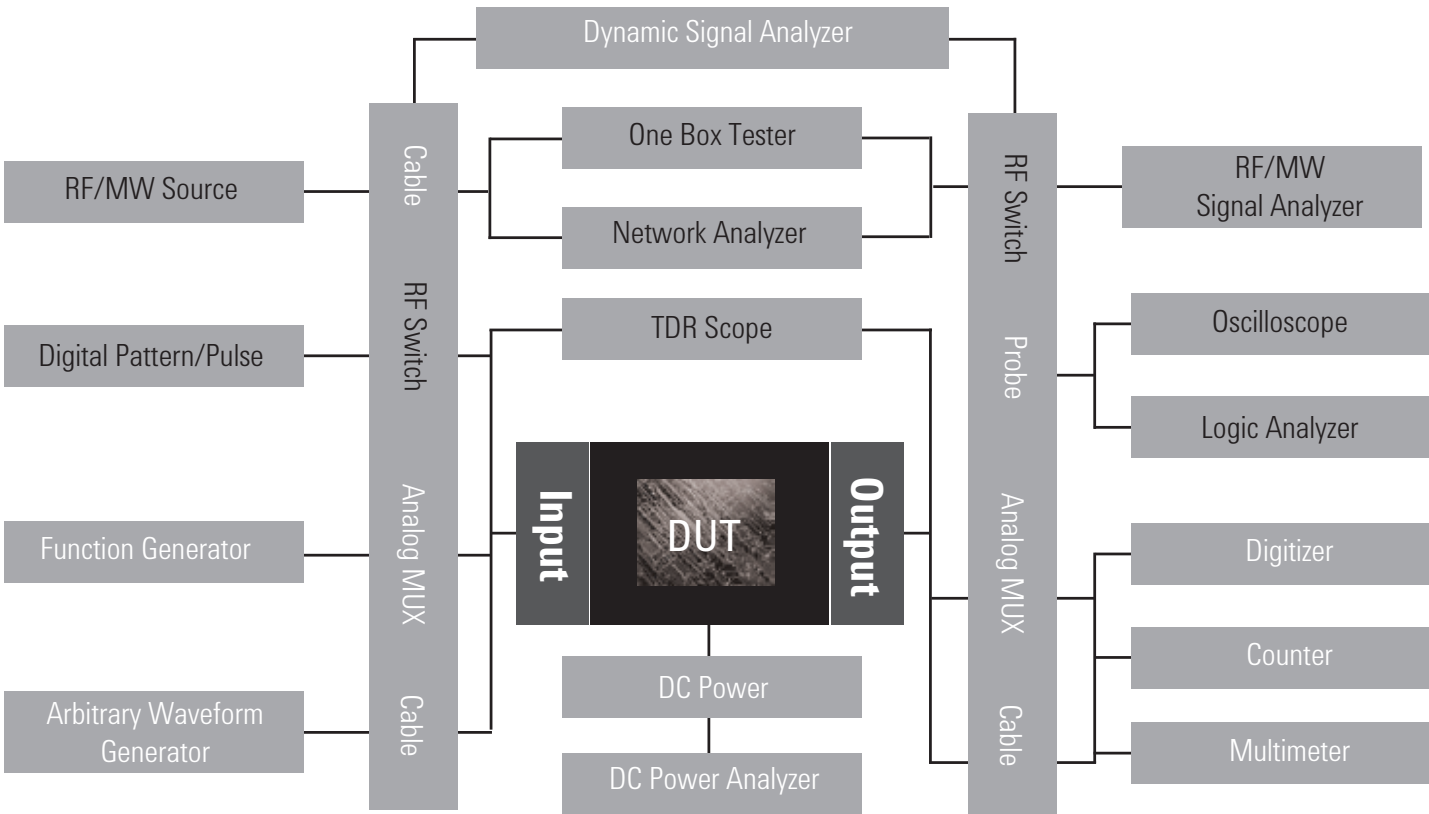

## Integrate Confidently. Switch Confidently.

### Measure Confidently ...only with Keysight

Whether you use switching to route signals for design verification applications or for complex automated functional test systems, reliable and repeatable switching is critical for your measurement accuracy. Keysight Technologies, Inc. switching ensures confidence in your measurement results.

- Reliable signal routing from DC to 67 GHz
- High quality, durable connections to your device under test
- Switch management features such as relay counters, switch verification and switch sequencer
- Compact, cost effective LAN, GPIB and USB solutions

#### Contents

34970A Data Acquisition/Switch System	4
34980A Multifunction Switch/Measure Unit	6
L4400 Series	8
USB Switching & Data Acquisition	10
3499 Switch Family	12
PXI Switches	14
VXI Switches	18
Electromechanical Switches	20
Solid State Switches	22
Switch Drivers	24
L449XA RF Switch Platforms	26
Custom Switch Solutions	28

## 34970A Data Acquisition/Switch System

Dedicated data-acquisition performance at PC plug-in prices

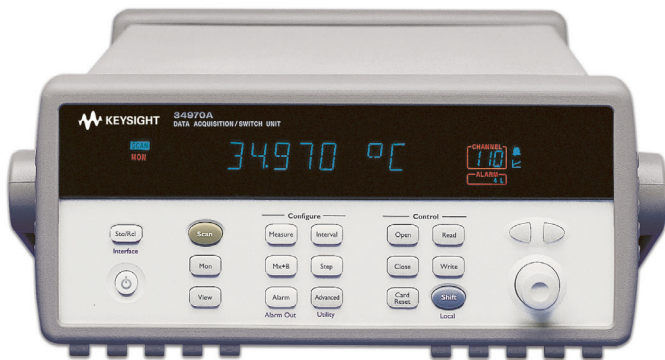

- Three-slot mainframe, choice of 8 plug-in modules
- Up to 60 2-wire mux or 96 2-wire matrix cross-points in one mainframe
- Built-in DMM with 6½ digits (22 bits) of resolution
- Scan rates of up to 250 channels/second
- Measures and converts 11 different input signals: temperature with thermocouples, RTDs, and thermistors; DC/AC volts; 2- and 4-wire resistance; frequency and period; DC/AC current
- Includes BenchLink Data Logger software to configure and control tests, display results and move data for further analysis

[www.keysight.com/find/34970A](http://www.keysight.com/find/34970A)

## Models and Specifications

Model	Description				
34970A	3-slot mainframe with internal 6½ digit DMM. GPIB, RS-232 and 50 K reading non-volatile memory with timestamp				
34970A Plug-in Modules	Description	Scan ch/sec	Max Voltage	Max Current	Comments
34901A	20 ch. multiplexer (2/4-wire)	60	300 V	1 A	2 current channels (22 ch. total); built-in cold junction reference; connects to internal DMM
34902A	16 ch. multiplexer (2/4 wire)	250	300 V	50 mA	Built-in cold junction reference; reed relays multiplex inputs to internal DMM
34903A	20-ch. actuator/GP switch	120	300 V	1 A	Form C (SPDT) switches; no connection to internal DMM
34904A	4x8 matrix	120	300 V	1 A	2-wire, full crosspoint; no connection to internal DMM
34905A	2 GHz dual 1:4 RF mux 50Ω	60	42 V	0.7 A	1 GHz through provided BNC-to-SMB adapter cables; no connection to internal DMM
34906A	2 GHz dual 1:4 RF mux 75Ω	60	42 V	0.7 A	1 GHz through provided BNC-to-SMB adapter cables; no connection to internal DMM
34907A	2, 8-bit digital I/O ports 26-bit, 100 kHz event counter 2,16-bit analogue outputs	NA	42 V 42 ±12 V	400 mA 10 mA	Open drain Gated, selectable input threshold; Earth referenced; calibrated; no connection to internal DMM
34908A	40-ch. single-ended mux	60	300 V	1 A	Common low, no 4-wire meas. Built-in cold junction reference; connects to internal DMM

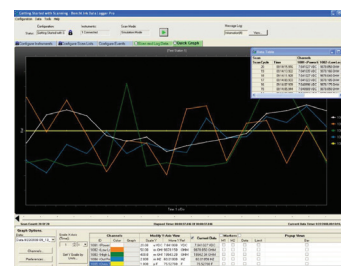

Included BenchLink Data Logger software makes it easy to capture data for further analysis.

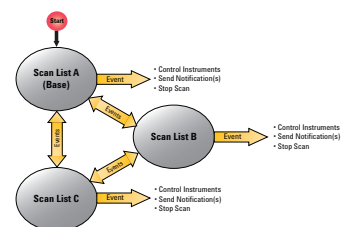

Keysight 34830A BenchLink Data Logger Pro allows for advanced data logging and decision making without programming

## Options and Accessories

- Option 001 Delete Internal DMM
- Option 1CM Rack mount kit
- 34307A 10-pack of J-type thermocouples
- 34308A 5-pack of 10 kΩ thermistors

## 34980A Multifunction Switch/Measure Unit

Flexible, reliable switching and data acquisition system in one compact, economical box



- Eight-slot mainframe, choice of 21-plug-in modules
- Up to 560 2-wire mux or 4096 matrix cross-points in one mainframe
- Built-in DMM with 6½ digits (22 bits) of resolution
- Scan rates of up to 1000 channels/second
- Standard LAN, USB, and GPIB connectivity to PC
- Easy remote access with built-in Web interface
- Priced up to 40% less than comparable module solutions in VXI or PXI
- Includes BenchLink Data Logger software to configure and control tests, display results and move data for further analysis

## Models and Specifications

Model	Description			
34980A	8-slot mainframe with optional internal 6½ digit DMM and 500k reading non-volatile memory with timestamp			
Plug-in Modules	Description	Max Voltage	Switch/Carry Current	Scan ch/sec
<b>Low-frequency multiplexers</b>				
34921A	40-channel armature mux w/ low thermal offset	±300 V	1A/2A	100
34922A	70-channel armature mux	±300 V	1A/2A	100
34923A	40 / 80-channel reed mux	±150 V	0.5A/1.5A	500
34924A	70-channel reed mux	±150 V	0.5A/1.5A	500
34925A	40 / 80-channel optically isolated FET multiplexer	±80 V	0.02A	1000
<b>Low-frequency matrix switches</b>				
34931A	Dual 4x8 armature matrix	±300 V	1A/2A	100
34932A	Dual 4x16 armature matrix	±300 V	1A/2A	100
34933A	Dual/Quad 4x8 reed matrix	±150 V	0.5A/1.5A	500
34934A	Quad 4x32 reed matrix	±100 V	0.5A/0.5A	500
<b>Low-frequency GP/actuator switches</b>				
34937A	28-channel Form C and 4-channel Form A	±300 V/±250 VAC	1A/2A /5 A	NA
34938A	20-channel 5-amp Form A	±250 VAC	5A/8A	NA
34939A	64-channels Form A	±100 VAC	1A/2A	NA
<b>RF and microwave modules</b>		<b>Insertion Loss</b>	<b>Isolation</b>	<b>Frequency Range</b>
34941A	Quad 1x4 50 ohm 3 GHz RF multiplexer	0.6 dB	> 58 dB	3 GHz
34942A	Quad 1x4 75 ohm 1.5 GHz RF multiplexer	0.6 dB	> 60 dB	1.5 GHz
34945A/EXT	Microwave switch/attenuator driver	Can drive up to 64 external switch coils. Comes with one 34945E XT and is expandable up to 8 34945EXTs. Expand with additional 34945EXTs		
34946A	Dual 1x2 SPDT terminated microwave switch 4GHz, 20GHz or 26.5GHz	< 0.42 dB < 0.69 dB < 0.8 dB	> 85 dB > 67 dB < 60 dB	< 1.15 < 1.30 < 1.6
34947A	Triple 1x2 SPDT unterminated microwave switch 4GHz, 20GHz or 26.5GHz	< 0.42 dB < 0.69 dB < 0.8 dB	> 85 dB > 67 dB < 60 dB	< 1.15 < 1.30 < 1.6
<b>System control modules</b>				
34950A	64-bit digital I/O with memory and counter	Eight 8-bit digital I/O channels with programmable polarity, handshaking protocols and pattern memory		
34951A	4-channel isolated D/A converter with waveform memory	C voltage up to ± 16 V or DC current up to ± 20 mA. 16 bits waveforms with a 200 kHz update rate		
34952A	Multifunction module with 32-bit DIQ, 2-ch D/A and totalizer	Four 8-bit digital I/O channels, two ± 12-V analog outputs, and a 100 kHz gated totalizer		
34959A	Breadboard module	Create your own custom designs with +12 V and +5 V supplies, 16 GPIO and 28 relay drive lines		

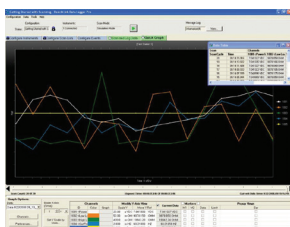

Keysight 34832A BenchLink Data Logger Pro software allows for advanced data logging and decision making without programming.

[www.keysight.com/find/34980A](http://www.keysight.com/find/34980A)

## L4400 Series LXI Switching and Control

High-performance switching and system control in a compact, self-contained LXI instrument



- LXI Class C Compliant
- Small, 1U, half-rack size
- Built-in Ethernet connectivity
- Fully-featured graphical Web interface
- Standard Dsub connectors for flexible connection options
- Software drivers for most common programming environments

[www.keysight.com/find/L4400](http://www.keysight.com/find/L4400)



## Models and Specifications

Model	Description			
<b>L4400 Series</b>	A broad range of functionality to meet a wide variety of applications needs in design verification, automated test and data acquisition			
	Description	Max Voltage	Max Current	Scan ch/sec
<b>Low Frequency Switching</b>				
L4421A	40 Channel Armature	±300 V	1 A	100
L4433A	Dual/Quad 4 x 8 Reed Matrix	±150 V	0.5 A	500
L4437A	28 Channel Form C 4 Channel Form A	300 V 30 VDC/250 VAC	1 A 5 A	N/A N/A
<b>RF and Microwave Switching</b>				
L4445A	Microwave Switch/Attenuator Driver	Drive up to 64 external switch coils; 32 SPDT switches, 8 multipoint switches, 8 attenuators, or custom combination		
<b>System Measurement and Control</b>				
L4450A	64-Bit Digital I/O with Memory and Counter	Eight 8-bit digital I/O channels with programmable polarity, thresholds up to 5 V with handshaking protocols and 128 kbytes pattern memory. Two 10 MHz frequency counters and programmable clock output		
L4451A	4 Channel Isolated D/A Converter with Memory	Output DCV up to ±16 V or DC current up to ±20 mA, output waveforms w/200 kHz update rate and 16 bit resolution. 500 k memory for waveform clock output		
L4452A	Multifunction	Four 8-bit digital I/O channels, 2 Channel ±12 V analog outputs, 100 kHz gated totalizer		

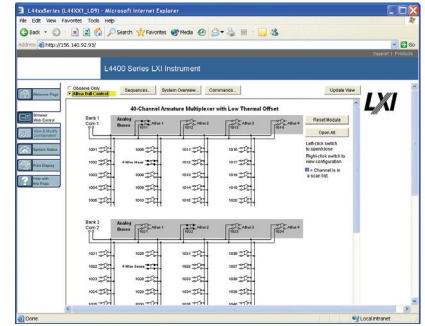

Web interface makes it easy to set up, troubleshoot and maintain your test remotely

## Options and Accessories

- Option GPIB adds GPIB interface
- Option OBO deletes printed manual set, full documentation included on CD ROM
- Option ABA printed English manual set
- 349xxT terminal blocks for connections
- Y1160A rack mount kit
- Y1135A - Y1142A twisted pair cables & connector kits

## USB Switching & Data Acquisition

Flexible choice for data logging, measurement or monitoring in a broad range of industries



- Standalone and modular capabilities
- Up to 3 MSa/s sampling rate (single channel; U2331A)
- Up to 384 channels when used in U2781A chassis
- Powerful analog and digital triggering capabilities
- 24-bit programmable digital I/O
- Plug-and-play installation and configuration
- High-speed USB 2.0 (480MBit/s)

## Models and Specifications

Model	Description
U2781A	USB Modular instrument chassis

### U2300A Series USB Multifunction DAQ, USB Plug-in or Standalone Modules

Model	Channel Count		Max Sampling Rate (kSa/s)		Resolution (bits)	
	Analog input	Analog output	Analog input	Analog output	Analog input	Analog output
<b>Basic Multifunction DAQ</b>						
U2351A	16 SE/8 DI	2	250	1000	16	16
U2352A	16 SE/8 DI	-	250	-	16	-
U2353A	16 SE/8 DI	2	500	1000	16	16
U2354A	16 SE/8 DI	-	500	-	16	-
<b>Basic Multifunction DAQ</b>						
U2355A	64 SE/32 DI	2	250	1000	16	12
U2356A	64 SE/32 DI	2	500	1000	16	12
U2331A	64 SE/32 DI	2	1000 (multiple channels) 3000 (single channel)	1000	12	12

### Thermocouple Input Signal Conditioners

Model	Channel Count	Max Input Voltage	Thermocouple Types Supported
U2802A	31	10 V	J, K, R, S, T, N, E, and B

### USB Matrix Switch

Model	Description	Max Inputs/Outputs (V, I)	Speed/Frequency	Channels/Crosspoints
U2751A	Multiplexer 2-Wire	42VDC (used standalone) 180VDC (used with cardcage U2781A) 2A	60 ch/sec	32 two-wire crosspoints (4x8)

## Options

- U2901A Terminal block and SCSI-II 68-pin connector with 1 meter cable for U2300 series
- U2902A Terminal block and SCSI-II 68-pin connector with 2 meter cable for U2300 series
- U2922A 32 channel Terminal block for U2751A

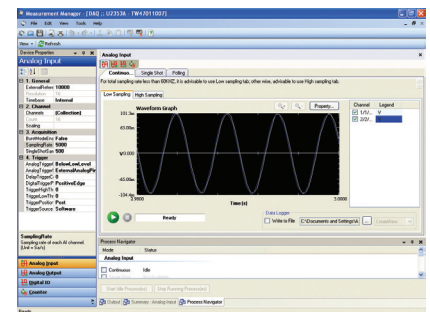

Keysight Measurement Manager application user interface

## 3499 Switch Family

The Keysight 3499 gets high marks in ATE environments worldwide



- Affordable, scalable switching platform with 21 modules to choose from
- 2, 5 and 14-slot Mainframes
- Intuitive, self-guiding front panel interface
- Scan up to 350 ch/sec
- GPIB and RS-232 interfaces
- Built-in Digital I/O

[www.keysight.com/find/3499](http://www.keysight.com/find/3499)

## Models and Specifications

Model	Description					
3499A	5-Slot Switch/Control Mainframe					
3499B	2-Slot Switch/Control Mainframe					
3499C	9/14-Slot Switch/Control Mainframe					
Plug-in Module	Description	Maximum Voltage	Maximum Current	Bandwidth		
<b>Multiplexers</b>						
N2260A	40-channel	200 V	1 A	10 MHz		
N2266A	40-channel	200 V	0.5 A	40 MHz		
44470A	10-channel	250 V	2 A	10 MHz		
44470D	20-channel	250 V	2 A	10 MHz		
<b>General-purpose Switches</b>						
N2261A	40-channel	200 V	1 A	10 MHz		
N2267A	8-channel	250 V	8 A	20 MHz		
44471A	10-channel	250 V	2 A	10 MHz		
44471D	20-channel	250 V	1 A	10 MHz		
<b>Matrix Switches</b>						
N2262A	4 x 8 matrix	200 V	1 A	10 MHz		
44473A	4 x 4 matrix	250 V	2 A	10 MHz		
<b>Digital I/O Modules</b>						
N2263A	32-bit TTL	42 V	0.6 A	NA		
44474A	16-bit TTL	30 V	0.125 A	NA		
<b>Multifunction Modules</b>						
N2264A	12 GP	200 V	1 A	10 MHz		
	3 GP	125 V	5 A	10 MHz		
	16-bit DIO	42 V	0.6	NA		
<b>RF &amp; Microwave Modules</b>						
Plug-in Modules	Description	Insertion Loss	Cross talk	SWR	Bandwidth	Impedance
N2268A	Dual 1 x 4	<0.35 dB	<-64 dB	<1.20	3.0 GHz	50 Ω
N2272A	Single 1 x 9	<0.5 dB	<-75 dB	<1.20	1.0 GHz	50 Ω
N2276A	Dual 1 x 6	<0.36 dB	<-100 dB	<1.20	26.5 GHz	50 Ω
44472A	Dual 1 x 4	<0.75 dB	<-85 dB	<1.12	300 MHz	50 Ω
44478A	Dual 1 x 4	<1.1 dB	<-70 dB	<1.35	1.3 GHz	50 Ω
44478B	Dual 1 x 4	<1.1 dB	<-70 dB	<1.35	1.3 GHz	75 Ω
44476A	Triple 1 x 2	<0.25 dB	<-90 dB	<1.15	18 GHz	50 Ω
44476B	Relay driver can support 2 microwave switches. Technical specs depend on the mounted relays					

## PXI Switch Modules

Experience fast reliable switching in a variety of configurations



Select from General Purpose, Matrix, Multiplexer and RF Switch modules for your switch test system. Add Digital I/O to your test system with the M9187A module.

- Optional connector blocks and cables
- Software driver support the most common programming environments (IVI-COM, IVI-C, LabVIEW)
- Soft front panels
- Keysight connections expert

## M9018A 18 Slot PXIe Chassis

- Advanced PCIe switch fabric that operates up to Gen 2 speeds and provides twelve x4 and four x8 links to module slots
- Backplane speeds of up to a 4 GB/s data rate from external controller to PXIe module slots
- Innovative cooling design that allows chassis to fit into 4U of rack space in most cases



## General Purpose PXI Switch Modules

- Up to 100 channels or armature relays
- Power relay module switches heavy loads with up to 300W (DC resistive load)/125W (AC resistive load)



## Matrix PXI Switch Modules

- Up to 256 2-wire crosspoints
- High-speed, long-life reed relays or higher power armature relay

## Multiplexer PXI Switch Modules

- High-speed, long-life reed relays or higher power armature relays
- Modules operate in break-before-make mode
- Up to 128 channels in a single module



## RF PXI Switch Modules

- Modern RF relay technology delivers low insertion loss and VSWR
- Reliable switch path design for repeatable RF performance

## Digital I/O PXI Modules

- 32 input channels and 32 output channels
- 100 V input protection and fully protected outputs

## PXI Switch Modules

### Options and Accessories

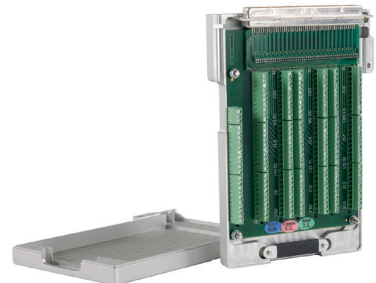
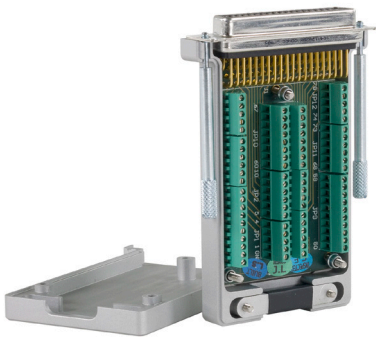

#### M9130A, M9120A, M9187A

- Y1181A\*      PXI connector block: 78 pin, shielded, female DSub
- Y1187A      PXI connector cable: 78 pin, male to female, 1 meter
- Y1188A      PXI connector cable 78 pin, male to female, 2 meter

#### M9131A, M9133A, M9121A, M9101A, M9102A, M9103A

- Y1182A\*      PXI connector block: 200 pin, shielded, male
- Y1189A      PXI connector cable: 200 pin, male to female, 1 meter
- Y1190A      PXI connector cable: 200 pin, male to female, 2 meter

#### M9135A

- Y1191A\*      PXI power cable: 20 pin, female to unterminated, 1 meter
- Y1192A      PXI power cable: 20 pin, female to unterminated, 2 meter
- Y1193A      PXI power connector: 20 pin, female (universal), solder pin

#### M9122A

- Y1180A\*      PXI connector block: 50 pin female DSub
- Y1185A      PXI connector cable: 50 pin, male to female, 1 meter
- Y1186A      PXI connector cable: 50 pin, male to female, 2 meter



## Models and Specifications

	Description	Number of slots	Height	Data bandwidth
<b>PXI Mainframe</b>				
M9018A	18-slot PXIe Chassis	16 PXIe Hybrid slots	4U	8 GB/sec
	Description	Switch Speed	Max voltage	Max Switch/ Carry Current
<b>General Purpose Switch Modules</b>				
M9130A	26 Ch, SPDT, armature relays	3 ms	Contact Factory	2A/2A
M9131A	64 Ch, SPDT, reed relays	250 $\mu$ s	100V	1A/1A
M9132A	50 Ch, SPDT, reed relays	0.5 ms	100V	1A/1A
M9133A	100 Ch, SPDT, reed relays	0.5 ms	100V	1A/1A
M9135A	20 Ch, SPDT, 10A, 300W	10.5 ms	Contact Factory	10A/10A
<b>Matrix Switch Modules</b>				
M9120A	4x32, 2-wire armature relays	3 ms	125V	2A/2A
M9121A	4x64, 2-wire reed relays	1 ms	100V	0.5A/0.5A
M9122A	8x32, 1-wire armature relays	3 ms	Contact Factory	2A/2A
<b>Multiplexer Switch Modules</b>				
M9101A	64 Ch, 2-wire, reed relays	500 $\mu$ sec	100V	0.5A/1.0A
M9102A	128 Ch, 1-wire, reed relays	500 $\mu$ sec	100V	0.5A/1.0A
M9103A	99 Ch, 2-wire, armature relays	3 ms	100V	1A/1A
	Description	Insertion loss (typical)	Isolation (typical)	VSWR (typical)
<b>RF Switch Modules</b>				
M9128A	RF Matrix 300 MHz, 50 $\Omega$	2 dB @ 300MHz	40 dB @ 300MHz	2:1 @ 300 MHz
M9146A	RF Multiplexer 3 GHz, 50 $\Omega$	1.0 dB @ 3 GHz	47 dB @ 3 GHz	1.3:1 @ 3 GHz
M9147A	RF Multiplexer 3 GHz, 50 $\Omega$	1.0 dB @ 3 GHz	43 dB @ 3 GHz	1.4:1 @ 3 GHz
M9148A	RF Multiplexer 3 GHz, 50 $\Omega$	0.8 dB @ 3 GHz	45 dB @ 3 GHz	1.25:1 @ 3 GHz
M9149A	RF Multiplexer 3 GHz, 50 $\Omega$	1.2 dB @ 3 GHz	40 dB @ 3 GHz	1.5:1 @ 3 GHz
M9150A	RF Multiplexer 3 GHz, 75 $\Omega$	1.0 dB @ 3 GHz	45 dB @ 3 GHz	1.5:1 @ 3 GHz
M9151A	RF Multiplexer 3 GHz, 75 $\Omega$	1.1 dB @ 3 GHz	40 dB @ 3 GHz	1.55:1 @ 3 GHz
M9152A	RF Multiplexer 3 GHz, 75 $\Omega$	1.0 dB @ 3 GHz	45 dB @ 3 GHz	1.6:1 @ 3 GHz
M9153A	RF Multiplexer 3 GHz, 75 $\Omega$	1.2 dB @ 3 GHz	40 dB @ 3 GHz	1.55:1 @ 3 GHz
M9128A	RF Matrix 300 MHz, 50 $\Omega$	2 dB @ 300MHz	40 dB @ 300MHz	2:1 @ 300 MHz
	Description	Switch speed	Inputs	Outputs
<b>Digital I/O Modules</b>				
M9187A	32 inputs, 32 outputs, 0.3V to 50V	1.3 ms	Up to 50V	Source .04A Sink 0.5A

## VXI Switches

A wide choice of modules for when you need high-performance, high-density switching

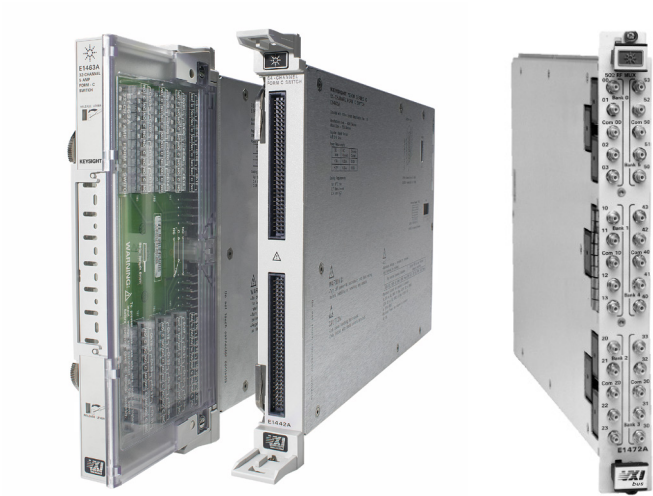

- Modular architecture allows for high-performance signal connections in the same platform as your VXIbus-based signal stimulus and measurement instruments
- Easily configured to over switching 3,000 channels
- Scan up to 13,000 ch/sec
- Wide selection of modules including multiplexers, general purpose, matrix and RF/Microwave switching
- GPIB and Firewire interfaces

## Models and Specifications

Plug-in modules	Description	Type	Max volts/current	Scan ch/sec
<b>Multiplexers</b>				
E1345A	16-Channel Low-Offset Relay Multiplexer	B-VXI	120V, 50mA	600 ch/s
E1347A	16-Channel T/C Low-Offset Relay Multiplexer	B-VXI	120V, 50mA	600 ch/s
E1352A	32-Channel Single-Ended FET Multiplexer	B-VXI	16V, 1mA	13000 ch/s
E1460A	64-Channel Relay Multiplexer	C-VXI	250V, 1A	72 ch/s
E1476A	64-Channel 3-wire T/C Relay Multiplexer	C-VXI	120V, 35mA	333 ch/s
E8460A	256-Channel High-Density Reed Relay Multiplexer	C-VXI	200V, 500mA	n/a
E8462A	256-Channel High-Density Relay Multiplexer	C-VXI	250V, 2A	n/a
<b>General-purpose Switches</b>				
E1364A	16-channel Form A	B-VXI	250V, 1A	n/a
E8462A	256-Channel High-Density Relay Multiplexer	C-VXI	250V, 2A	n/a
E1442A	64-Channel Form C or Form A Switch	C-VXI	150V, 1A	n/a
E1463A	32-Channel, 5 Amp, Form C VXI Switch	C-VXI	125V, 5A	n/a
E8480A	40-Channel, 12 Amp General Purpose Switch	C-VXI	150V, 12A	n/a
<b>Matrix Switches</b>				
E1465A	16 x 16 Relay Matrix Switch	C-VXI	200V, 1A	n/a
E1466A	4 x 64 Relay Matrix Switch	C-VXI	200V, 1A	n/a
E1467A	8 x 32 Relay Matrix Switch	C-VXI	200V, 1A	n/a
E1468A	8 x 8 Relay Matrix Switch	C-VXI	250V, 1A	n/a
<b>RF/Microwave Switches</b>				
E1366A	Dual 1x4 50 Ohm, RF Multiplexer	B-VXI	42V, 1A	1.3 GHz
E1368A	18 GHz Microwave Switch (3 channels)	B-VXI	30V, 1A	18GHz
E1369A	Microwave Switch/Step Attenuator Driver	B-VXI	n/a	n/a
E1370A	Microwave Switch/Step Attenuator Driver	B-VXI	n/a	n/a
E1472A	Six 1 x 4 50 Ohm, RF Multiplexer	C-VXI	42V, 1A	1.3 GHz
E1473A	Six 1 x 4, 50 Ohm RF Multiplexer Expander	C-VXI	42V, 1A	1.3 GHz
E1474A	Six 1 x 4, 75 Ohm RF Multiplexer	C-VXI	42V, 1A	1.3 GHz
E1475A	Six 1 x 4, 75 RF Multiplexer Expander	C-VXI	42V, 1A	1.3 GHz
E1339A	72-Channel Digital Output/Relay Driver	C-VXI	Na	na

# Electromechanical Switches

Superior performance with guaranteed specifications to 50 GHz



- High reliability and exceptional repeatability ensure excellent measurement accuracy
- Excellent RF specifications optimize your test system capability
- Broad selection of switches provides configuration flexibility for various applications



[www.keysight.com/find/switches](http://www.keysight.com/find/switches)

## Models and Specifications

Electromechanical switches							
Frequency Configuration	SPDT	SP3T	SP4T	SP5T	SP6T	Bypass	Transfer
DC to 4 GHz	■		■		■		
DC to 18 GHz	■					■	
DC to 20 GHz	■		■		■		
DC to 26.5 GHz	■	■	■	■	■	■	■
DC to 40 GHz	■		■		■		■
DC to 50 GHz			■	■	■		■

### Keysight's electromechanical switch product offerings

Terminated	High performance	Low cost
SPDT	N1810TL	8762A/B/C/F
SP4T	87104A/B/C/D	L7104A/B/C/D
SP6T	87106A/B/C/D	L7106A/B/C/D
Bypass	N1811TL	8763A/B/C
Unterminated	High performance	Low cost
SPDT	N1810UL	8765A/B/C/D/F
SP4T	8767K	L7204A/B/C
SP6T	8769K	L7206A/B/C
Bypass	N1812UL	8764A/B/C
Transfer	87222C/D/E	L7222C

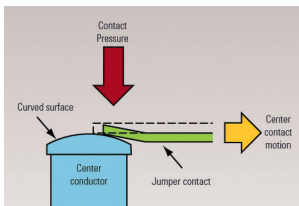

EM switch mating configuration illustrating microscopic wiping

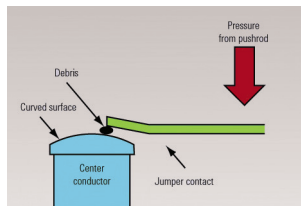

A piece of small debris is stuck on the surface of center conductor

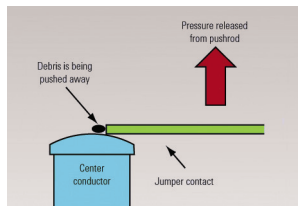

Debris is wiped from the surface

### Guaranteed Performance

<0.03 dB insertion loss  
repeatability guaranteed for 2 or 5 million cycles

### Long Operation Life

5 or 10 million cycles (typical)

### Flexible Configurations

- SPDT, SP4T, SP6T
- Bypass and transfer
- Terminated and unterminated

### High Isolation

Typically > 85 dB at 26.5 GHz

### Low SWR

Minimize measurement uncertainty

### Unique Design

Wiping action mechanism eliminates particle buildup to ensure reliable switching

### Broad Frequency Range

DC to 4, 20, 26.5, 40, or 50 GHz

# Solid State Switches

High speed, long life solid state switches to 50 GHz

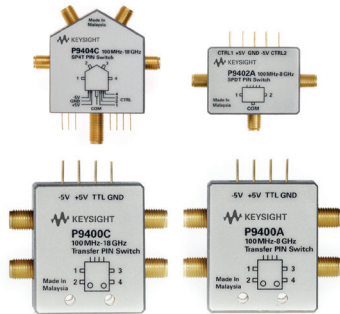

- Superior performance with high isolation
- Fast switching speed across a broad operating frequency range
- Safe, accurate test for sensitive RFIC components

[www.keysight.com/find/switches](http://www.keysight.com/find/switches)

## Models and Specifications

Solid State Switches						
Frequency Configuration	SPDT	FET Hybrid SP4T	Transfer	SPDT	PIN Diode SP4T	Transfer
300 kHz to 8 GHz	■		■			
100 MHz to 8 GHz				■	■	■
300 kHz to 18 GHz	■		■			
100 MHz to 18 GHz				■	■	■
45 MHz to 50 GHz				■	■	
Keysight's solid state switch product offerings						
Frequency	SPDT	FET Hybrid SP4T	Transfer	SPDT	PIN Diode SP4T	Transfer
300 kHz to 8 GHz	U9397A		U9400A			
100 MHz to 8 GHz				P9402A	P9404A	P9400A
300 kHz to 18 GHz	U9397C		U9400C			
100 MHz to 18 GHz				P9402C	P9404C	P9400C
45 MHz to 50 GHz				85331B	85332B	

### Fast Switching Speed

350  $\mu$ s (typical)

### High Isolation

>100 dB at 8 GHz

### Low Video Leakage

Prevent damage to sensitive components

### Broad Frequency Range

- From kHz to 8, 18 or 50 GHz
- Low frequency testing

### Low SWR

Minimize measurement uncertainty

### Exceptionally Long Operating Life

## Switch Drivers

Completing your switch solutions with switch drivers



- Flexible, standalone switch drivers
- Quickly and easily connect to your switches
- Control from just a few to over 256 high frequency switches
- Use on the bench or in an ATE environment
- LAN, GPIB and RS-232 interfaces

[www.keysight.com/find/switchdrivers](http://www.keysight.com/find/switchdrivers)



## Models and Specifications

Switch Driver Quick Selection Chart

Feature	11713B/C	L4445A	L4490/91A	34980A with 34945A	U2121
Front panel control	Yes	No	No	Yes	No
LCD display	Yes	No	No	Yes	No
Application	Bench-top and ATE in fixture	ATE with switches in fixture	ATE with switches in rack	ATE with mixed signal needs	Small ATE
Capacity	Up to 20 channels	32 channels standard expandable to 256 switches	32 channels standard; expandable to 64 switches	32 channels standard; expandable to 256 switches	5 SPDT switches
Physical size	2½U	1U, ½ rack	2U/4U	3U mainframe	154 mm x 120 mm x 32.6 mm
Voltage supply <sup>1</sup>	5 V, 15 V, 24 V	24 V (external power supply needed for 5 V and 15 V)	5 V, 12 V, 24 V	24 V (external power supply needed for 5 V and 15 V)	5V, 24V
Connectivity	GPIB, USB, LAN (LXI Class C)	LAN (optional GPIB) (LXI Class C)	GPIB, LAN (LXI Class C)	GPIB, USB, LAN (LXI Class C)	USB

<sup>1</sup> All switch drivers are programmable to 30 V with an external power supply

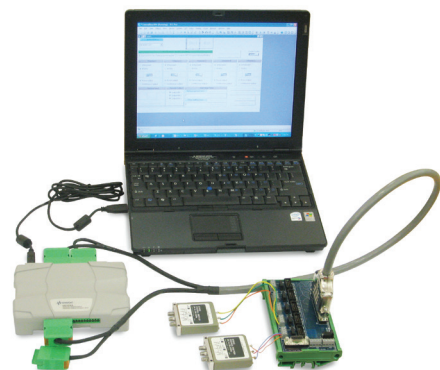

U2121A USB Digital IO with RF Switching Options



11713B/C Attenuator/Switch Driver

[www.keysight.com/find/switchdrivers](http://www.keysight.com/find/switchdrivers)

## L449XA RF Switch Platforms

Shorten your custom switch matrix development time with a robust, reliable solution



- Flexible and easily configurable switch mounting system for a robust and reliable signal routing system
- 3D models for quick layout and documentation of RF switches and cables
- Graphical Web interface for quick setup, troubleshooting and support
- Easy connection and control of all the most popular microwave switches and attenuators
- Effective switch management with user-defined sequences, relay counter, exclude lists, and switch closure verification
- Software drivers for all the most common programming environments
- LXI compliance includes Web interface and built-in Ethernet connectivity

[www.keysight.com/find/L4490A](http://www.keysight.com/find/L4490A)

## Models and Specifications

The L449xA RF Switch Platforms provide the tools for Engineers to build their own custom switch solution. These platforms include power, switch drive control and space to mount all the most popular switches, attenuators and other signal conditioning components.

	L4490A	L4491A
Height	2U	4U
Control Lines	64	64 to 128
Power Supply	5 V, 12 V, 24 V	5 V, 12 V, 24 V
24VDC Current Available	600 mA	600 mA
Sequence Memory	512 K, non volatile	512 K, non volatile
Connectivity	LAN, GPIB	LAN, GPIB
Drivers	IVI-C, IVI-Com, LabView	IVI-C, IVI-Com, LabView



L4491A RF Switch Platform configured as a 4 X 4 matrix

## Options and Accessories

- Y1150A-Y1156A Distribution boards for routing control signals to RF/ $\mu$ W switches and attenuators
- Y1170A-Y1175A Bracket/ribbon cable kits for mounting switches and attenuators in L4490A/91A.



Easily service and replace components

[www.keysight.com/find/L4491A](http://www.keysight.com/find/L4491A)

## Custom Switch Solutions

Custom RF switch solutions from Keysight

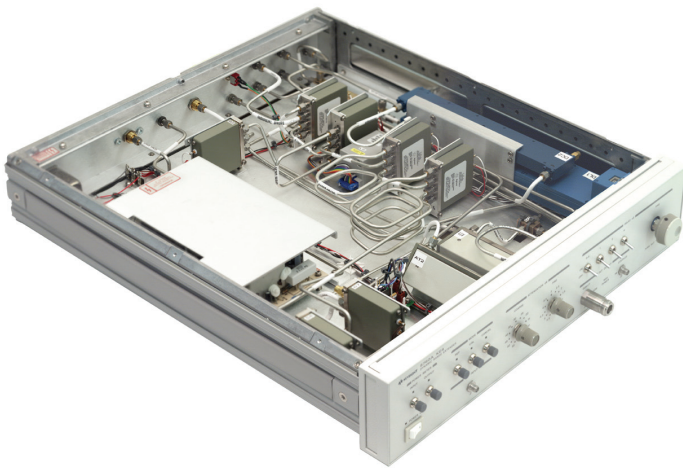

- Aerospace/Defense and Wireless RF/microwave designed switching and signal conditioning solutions
- Deep expertise in RF/microwave instrumentation and measurement science
- Optimal solutions for switch matrices
- Cost effective solutions designed for specific applications
- Experienced system service and support

[www.keysight.com/find/switchmatrix](http://www.keysight.com/find/switchmatrix)

## Specifications

Attribute	Specifications and Descriptions
Frequency Range	DC to 70 GHz
RF Switching	Mechanical or solid state switches from Keysight or 3rd party
RF Power	$\mu$ W to kW
RF Signal conditioning	Couplers, attenuators (fixed and variable), isolators, circulators, terminators, amplifiers, etc. Selected for frequency and power requirements
Design parameters	Isolation, Insertion loss, VSWR, reliability and repeatability as well as serviceability
Switch control	LXI, SCPI over LAN, GPIB or custom
Connectors	All standard types (N, SMA, 3.5 mm 2.92mm, etc.)
Packaging	Rack mount, bench top, ruggedized/mobile Custom front panel display available
Testing	Full RF path characterization
Documentation	Standard reference manual with test data, parts list and, and programming information comes.

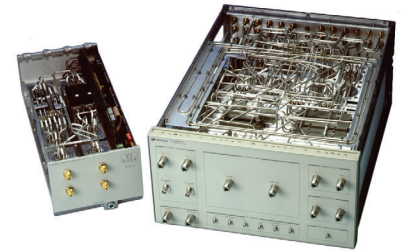
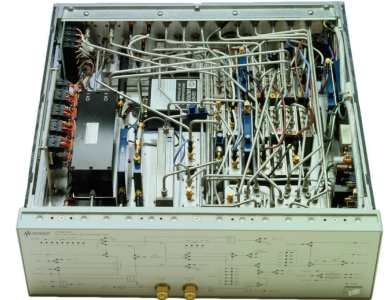

## Options and Accessories

- Custom or standard chassis enclosures
- Flexible or semi-rigid cables
- Available front panel options showing RF schematic with LED active path indicators
- Complete RF path characterization data (S parameters)
- Position read-back for automated systems
- Built in fault isolation capability
- Embedded calibration and calibration verification capability

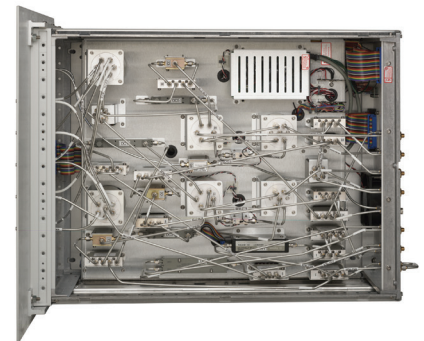

Keysight Custom Switch Solutions

[www.keysight.com/find/switchmatrix](http://www.keysight.com/find/switchmatrix)

# The Move is On.

More and more companies are moving their test systems to the LAN eXtensions for Instrumentation (LXI) platform. As test engineers have discovered how easy it is to create and reconfigure test systems with LXI, momentum for this new standard has grown worldwide.

Using LXI to boost throughput in semiconductor manufacturing

Every millisecond counts when testing semiconductor devices used in cellular phones. For one multinational manufacturer, an LXI-based test system shaved 2800 ms off the time required to test W-CDMA power amplifier ICs.

<http://cp.literature.keysight.com/litweb/pdf/5989-6616EN.pdf>



Now is the time to make sure your future test systems are LXI compliant. With the broadest selection of LXI instruments in the industry, Keysight will help you make the move. LXI delivers real benefits now, plus flexibility for the future.



[www.keysight.com/find/open](http://www.keysight.com/find/open)

LXI provides flexibility for testing automobile antenna amplifiers

LXinstruments recently built a system for testing automotive antenna amplifiers for a German automobile manufacturer. The LXI-based test system gave the car manufacturer the flexibility it needs to adapt to changing requirements.

<http://cp.literature.keysight.com/litweb/pdf/5989-6398EN.pdf>

**Free tools to help you gain momentum in LXI:**

Take advantage of these tools to help you simplify system integration.

- Test System Developers Guide
- Keysight Open Brochure
- LXI Fundamentals Poster

**Visit the Web site to order the CD that contains these tools and more!**

**New Keysight LXI Digitizers with high-performance front-ends and on-board measurements to save you time**

The Keysight L4532A and L4534A 20 MSa/s LXI digitizers offer 2 or 4 input channels in a stand-alone LXI format. These New LXI digitizers feature individually isolated inputs with an A/D converter per channel to ensure accurate waveform acquisition and measurements.

- 20 M Samples per second
- 16-bit ADC Simultaneous sampling
- $\pm 250$  mV to  $\pm 250$  V Isolated inputs
- Standard 32 MS/Ch or Extended 128 MS/Ch memory
- On-board measurements
- Built-in Web Interface
- Gigabit LAN and USB interfaces



[www.keysight.com/find/lxidigitizer](http://www.keysight.com/find/lxidigitizer)

[www.keysight.com/find/open](http://www.keysight.com/find/open)

## Evolving Since 1939

Our unique combination of hardware, software, services, and people can help you reach your next breakthrough. We are unlocking the future of technology.

From Hewlett-Packard to Agilent to Keysight.



For more information on Keysight Technologies' products, applications or services, please contact your local Keysight office. The complete list is available at:

[www.keysight.com/find/contactus](http://www.keysight.com/find/contactus)

### Americas

Canada	(877) 894 4414
Brazil	55 11 3351 7010
Mexico	001 800 254 2440
United States	(800) 829 4444

### Asia Pacific

Australia	1 800 629 485
China	800 810 0189
Hong Kong	800 938 693
India	1 800 11 2626
Japan	0120 (421) 345
Korea	080 769 0800
Malaysia	1 800 888 848
Singapore	1 800 375 8100
Taiwan	0800 047 866
Other AP Countries	(65) 6375 8100

### Europe & Middle East

Austria	0800 001122
Belgium	0800 58580
Finland	0800 523252
France	0805 980333
Germany	0800 6270999
Ireland	1800 832700
Israel	1 809 343051
Italy	800 599100
Luxembourg	+32 800 58580
Netherlands	0800 0233200
Russia	8800 5009286
Spain	800 000154
Sweden	0200 882255
Switzerland	0800 805353
	Opt. 1 (DE)
	Opt. 2 (FR)
	Opt. 3 (IT)
United Kingdom	0800 0260637

For other unlisted countries:

[www.keysight.com/find/contactus](http://www.keysight.com/find/contactus)  
(BP-9-7-17)

**DEKRA Certified**  
ISO 9001 Quality Management System

[www.keysight.com/go/quality](http://www.keysight.com/go/quality)  
Keysight Technologies, Inc.  
DEKRA Certified ISO 9001:2015  
Quality Management System

### myKeysight

#### myKeysight

[www.keysight.com/find/mykeysight](http://www.keysight.com/find/mykeysight)

A personalized view into the information most relevant to you.

[http://www.keysight.com/find/emt\\_product\\_registration](http://www.keysight.com/find/emt_product_registration)

Register your products to get up-to-date product information and find warranty information.

### KEYSIGHT SERVICES

Accelerate Technology Adoption.  
Lower costs.

#### Keysight Services

[www.keysight.com/find/service](http://www.keysight.com/find/service)

Keysight Services can help from acquisition to renewal across your instrument's lifecycle. Our comprehensive service offerings—one-stop calibration, repair, asset management, technology refresh, consulting, training and more—helps you improve product quality and lower costs.



#### Keysight Assurance Plans

[www.keysight.com/find/AssurancePlans](http://www.keysight.com/find/AssurancePlans)

Up to ten years of protection and no budgetary surprises to ensure your instruments are operating to specification, so you can rely on accurate measurements.

#### Keysight Channel Partners

[www.keysight.com/find/channelpartners](http://www.keysight.com/find/channelpartners)

Get the best of both worlds: Keysight's measurement expertise and product breadth, combined with channel partner convenience.

[www.keysight.com/find/modules](http://www.keysight.com/find/modules)



This information is subject to change without notice.  
© Keysight Technologies, 2017  
Published in USA, December 1, 2017  
5989-9872EN  
[www.keysight.com](http://www.keysight.com)