

Operating and Service Manual

Agilent Technologies 85037A/B Precision Detectors

Serial Numbers

This manual applies directly to Agilent 85037A/B detectors with serial number 00101 and above.



Part Number: 85037-90013

Printed in USA

October 2002

Supersedes November 2001

© Copyright 1992–1993, 2001, 2002 Agilent Technologies, Inc.

Notice.

The information contained in this document is subject to change without notice.

Agilent Technologies makes no warranty of any kind with regard to this material, including but not limited to, the implied warranties of merchantability and fitness for a particular purpose. Agilent shall not be liable for errors contained herein or for incidental or consequential damages in connection with the furnishing, performance, or use of this material.

Hewlett-Packard to Agilent Technologies Transition

This documentation supports a product that previously shipped under the Hewlett-Packard company brand name. The brand name has now been changed to Agilent Technologies. The two products are functionally identical, only our name has changed. The document still includes references to Hewlett-Packard products, some of which have been transitioned to Agilent Technologies.

Certification

Agilent Technologies certifies that this product met its published specifications at the time of shipment from the factory. Agilent further certifies that its calibration measurements are traceable to the United States National Institute of Standards and Technology, to the extent allowed by the Institute's calibration facility, and to the calibration facilities of other International Standards Organization members.

DOCUMENTATION WARRANTY

THE MATERIAL CONTAINED IN THIS DOCUMENT IS PROVIDED "AS IS," AND IS SUBJECT TO BEING CHANGED, WITHOUT NOTICE, IN FUTURE EDITIONS. FURTHER, TO THE MAXIMUM EXTENT PERMITTED BY APPLICABLE LAW, AGILENT DISCLAIMS ALL WARRANTIES, EITHER EXPRESS OR IMPLIED WITH REGARD TO THIS MANUAL AND ANY INFORMATION CONTAINED HEREIN, INCLUDING BUT NOT LIMITED TO THE IMPLIED WARRANTIES OF MERCHANTABILITY AND FITNESS FOR A PARTICULAR PURPOSE. AGILENT SHALL NOT BE LIABLE FOR ERRORS OR FOR INCIDENTAL OR CONSEQUENTIAL DAMAGES IN CONNECTION WITH THE FURNISHING, USE, OR PERFORMANCE OF THIS DOCUMENT OR ANY INFORMATION CONTAINED HEREIN. SHOULD AGILENT AND THE USER HAVE A SEPARATE WRITTEN AGREEMENT WITH WARRANTY TERMS COVERING THE MATERIAL IN THIS DOCUMENT THAT CONFLICT WITH THESE TERMS, THE WARRANTY TERMS IN THE SEPARATE AGREEMENT WILL CONTROL.

Assistance

Product maintenance agreements and other customer assistance agreements are available for Agilent products.

For any assistance, contact your nearest Agilent Technologies Sales and Service Office. Refer to Table 6-3, "Contacting Agilent" in Chapter 6.

Safety Notes

The following safety notes are used throughout this manual. Familiarize yourself with each of the notes and its meaning before operating this instrument.

Caution

Caution denotes a hazard. It calls attention to a procedure that, if not correctly performed or adhered to, could result in damage to or destruction of the instrument. Do not proceed beyond a *caution* sign until the indicated conditions are fully understood and met.

Warning

***Warning* denotes a hazard. It calls attention to a procedure which, if not correctly performed or adhered to, could result in injury or loss of life. Do not proceed beyond a *warning* note until the indicated conditions are fully understood and met.**

Instruction Manual



The **instruction manual** symbol. The product is marked with this symbol when it is necessary for the user to refer to the instructions in the manual.

ICES/NMB-001

This ISM device complies with Canadian ICES-001.
Cet appareil ISM est conforme a la norme NMB-001 du Canada.

Contents

1. General Information	
Introduction	1-1
Product Description	1-1
Instruments Covered by This Manual	1-1
Accessories	1-2
Equipment Required but Not Supplied	1-2
Recommended Test Equipment	1-2
Reflection or Transmission Measurements	1-2
AC Detection	1-2
Specifications and Supplemental Characteristics	1-2
2. Installation	
Safety Considerations	2-1
Initial Inspection	2-1
Preparation for Use	2-2
Electrostatic Discharge (ESD)	2-2
Static-Safe Workstation	2-2
Static-Safe Practices	2-2
Power Requirements	2-3
Cable Lead Identification	2-3
Mating Connectors	2-3
Connecting an 85037A/B	2-3
Mating a Precision 3.5 mm Connector to an SMA Connector	2-4
Electrical Performance	2-4
Operating Environment	2-6
Storage and Shipment	2-6
Environment	2-6
Packaging	2-6
Returning a Detector for Service	2-7
3. Operation	
Operating Theory	3-1
AC Detection	3-1
DC Detection	3-1
Features	3-2
Connector Torque Values	3-2
Operator's Check	3-3
Operating Modes and Specifications	3-3
Dynamic Accuracy	3-3
Frequency Response	3-3
Measurement System Configuration	3-4

DC Detection Measurements	3-5
Enabling the DC Detection Mode	3-5
Making Accurate DC Measurements	3-5
Operation	3-5
Zeroing an 85037A/B	3-5
AC Detection Measurements	3-6
Making Accurate AC Measurements	3-6
Characterizing the Detector (Performing a Power Calibration)	3-7
4. Performance Tests	
Introduction	4-1
Equipment Required	4-1
Return Loss at a Nominal -10 dBm	4-2
Description	4-2
Procedure	4-3
Frequency Response at a Nominal -10 dBm	4-5
Description	4-5
Procedure	4-6
Configuring the System	4-6
Measuring the Source	4-7
Measuring the Detector	4-7
Computing the Maximum Error	4-8
Dynamic Power Accuracy	4-10
Description	4-10
Procedure	4-10
First Alternate Dynamic Power Accuracy	4-11
Description	4-11
Second Alternate Dynamic Power Accuracy	4-12
Description	4-12
Procedure	4-12
5. Adjustments	
Introduction	5-1
Coarse Zero Adjustment	5-2
Description	5-2
Procedure	5-2
Feedthrough Nulling Adjustment	5-3
Description	5-3
Procedure	5-3
6. Replaceable Parts	
Introduction	6-1
Ordering Parts	6-1

7. Service	
Error Messages	7-1
Repair	7-1
Replacing the Detector	7-2
Removing the Covers	7-2
Replacing the Cable Assembly (W1)	7-3
A. Caring for Connectors	
Visual Inspection	A-1
Cleaning	A-1
Mechanical Inspection	A-2

Index

Figures

2-1. Example of a Static-Safe Workstation	2-2
2-2. Using Precision 7 mm Connectors	2-3
2-3. SMA and 3.5 mm Connector Cross-Sections and SWR Performance	2-5
3-1. Detector Features	3-2
3-2. Typical Measurement Setup	3-4
4-1. Return Loss Setup	4-2
4-2. Frequency Response Test Setup	4-5
4-3. Frequency Response Graph	4-9
4-4. Dynamic Power Accuracy Test Setup	4-11
4-5. First Alternate Dynamic Power Accuracy Test Setup	4-11
4-6. Second Alternate Dynamic Power Accuracy Test Setup	4-12
5-1. Coarse Zero/Feedthrough Nulling Adjustment	5-2
5-2. Coarse Zero Adjustment	5-3
5-3. Feedthrough Nulling Adjustment	5-4
6-1. Detectors and Cable Marker Kit	6-2
6-2. Module Exchange Program	6-4
7-1. Removing the Detector Covers	7-2
7-2. Cable Connections	7-4

Tables

1-1. Agilent 85037A Standard ¹	1-3
1-2. Agilent 85037B Specifications ¹	1-4
1-3. Supplemental Characteristics	1-5
1-4. Recommended Test Equipment	1-6
4-1. Return Loss Equipment Table	4-3
4-2. Frequency Response Equipment Table	4-6
4-3. Worksheet	4-9
4-4. Additional Equipment	4-12
4-5. Test Record for 85037A	4-13
4-6. Test Record for 85037A Option 001	4-17
4-7. Test Record for 85037B	4-21
6-1. Miscellaneous Parts	6-2
6-2. Replaceable Parts and Accessories	6-3
6-3. Contacting Agilent	6-5

General Information

Introduction

This manual contains information on operating, testing, and servicing the Agilent 85037A and 85037B precision detectors. Figure 6-1 shows the detectors and the supplied cable marker kit.

Product Description

The Agilent 85037A/B precision detectors are specifically designed for use with an Agilent 8757D scalar network analyzer and are not compatible with the Agilent 8757A/C/E, 8756, or 8755 scalar network analyzers. These dual-diode detectors may be used in either AC or DC detection modes. For improved power measurement accuracy versus frequency, each Agilent 85037 series precision detector includes detector-specific frequency response data, stored in an internal EEPROM, which is automatically read by the 8757D. When used in conjunction with the 8757D's internal power calibrator (Option 002), these detectors provide the maximum absolute power measurement accuracy.

Agilent Detector	Connector Type
85037A	Type-N (m)
85037A Option 001	Precision 7 mm
85037B	Precision 3.5 mm (m)

Instruments Covered by This Manual

Each detector has a unique serial number. The contents of this manual apply directly to detectors with serial numbers listed on the title page.

Accessories

Table 6-2 lists accessories available for use with these detectors.

Equipment Required but Not Supplied

Recommended Test Equipment

Table 1-4 lists the equipment required to test the detectors. You may substitute any equipment that meets the indicated critical specifications.

Reflection or Transmission Measurements

Reflection and transmission measurements require the following equipment:

- One or more detectors.
- An Agilent 8757D scalar network analyzer.
- *One* of the following:
 - A directional bridge.
 - A directional coupler.
- A sweep oscillator or synthesized sweeper.

For ratio measurements use:

- A power splitter or dual directional coupler.

AC Detection

AC detection requires the equipment listed above, *plus* either a signal source capable of 27.778 kHz squarewave amplitude modulation, or an external modulator.

Specifications and Supplemental Characteristics

Table 1-1 and Table 1-2 list detector specifications which are the performance standards or limits against which you can test the device.

Table 1-3 lists supplemental (typical, non-warranted) detector characteristics.

Table 1-1. Agilent 85037A Standard¹

Connector		
Standard	Type-N (m)	
Option 001	Precision 7 mm	
Frequency Range	0.01 to 18 GHz	
Return Loss		
0.01 to 0.04 GHz	10 dB	
0.04 to 18 GHz	20 dB	
Frequency Response²		
0.01 to 0.04 GHz	±0.30 dB	
0.04 to 18 GHz	±0.20 dB	
Dynamic Range		
AC mode	+20 to -55 dBm	
DC mode	+20 to -50 dBm	
DC Absolute Power Accuracy^{3,5}		
Power (dBm)	Corrected (±dB)	Default (±dB)
+20	0.25	0.40
+10	0.11	0.40
-30	0.11	0.40
-40	0.40	0.80
-50	0.85	1.30
AC Dynamic Power Accuracy^{3,4}		
Power (dBm)	Corrected (±dB)	Default (±dB)
+20	0.25	0.40
+10	0.11	0.40
-30	0.11	0.40
-40	0.40	0.80
-50	0.85	1.30
-55	0.85	1.30
Temperature Coefficient of Linearity	0.01 dB/°C temp. change after calibration.	

¹ The 85037A/B specifications only apply when used with the 8757D scalar network analyzer.

² -10 dBm, 25 ±5 °C

³ The corrected specifications apply after a calibration via the 8757D Option 002 internal calibrator. The default specifications apply when the calibrator is not used. Power calibrator uncertainty is included in the 85037A/B corrected specifications.

⁴ Dynamic accuracy refers to measurement accuracy as power varies (in dB) from a 0 dBm reference. 25 ±5 °C, 50 MHz, calibration and measurement at the same temperature.

⁵ DC mode, 25 ±5 °C, calibration and measurement at the same temperature.

Table 1-2. Agilent 85037B Specifications¹

Connector	3.5 mm (m)	
Frequency Range	0.01 to 26.5 GHz	
Return Loss		
0.01 to 0.04 GHz	10 dB	
0.04 to 18 GHz	20 dB	
18 to 26.5 GHz	18 dB	
Frequency Response²		
0.01 to 0.04 GHz	±0.30 dB	
0.04 to 18 GHz	±0.20 dB	
18 to 26.5 GHz	±0.30 dB (85037B only)	
Dynamic Range		
AC mode	+20 to -55 dBm	
DC mode	+20 to -50 dBm	
DC Absolute Power Accuracy^{3,5}		
Power (dBm)	Corrected³ (±dB)	Default (±dB)
+20	0.25	0.40
+10	0.11	0.40
-30	0.11	0.40
-40	0.40	0.80
-50	0.85	1.30
AC Dynamic Power Accuracy^{3,4}		
Power (dBm)	Corrected (±dB)	Default (±dB)
+20	0.25	0.40
+10	0.11	0.40
-30	0.11	0.40
-40	0.40	0.80
-50	0.85	1.30
-55	0.85	1.30
Temperature Coefficient of Linearity	0.01 dB/°C temp. change after calibration.	

¹ The 85037A/B specifications only apply when used with the 8757D scalar network analyzer.

² -10 dBm, 25 ±5 °C

³ The corrected specifications apply after a calibration via the 8757D Option 002 internal calibrator. The default specifications apply when the calibrator is not used. Power calibrator uncertainty is included in the 85037A/B corrected specifications.

⁴ Dynamic accuracy refers to measurement accuracy as power varies (in dB) from a 0 dBm reference. 25 ±5 °C, 50 MHz, calibration and measurement at the same temperature.

⁵ DC mode, 25 ± 5 °C, calibration and measurement at the same temperature.

Table 1-3. Supplemental Characteristics

Cable Length	1.22m (48 in)
Weight	
Net	0.24 kg (0.5 lb)
Shipping	1 kg (2.2 lb)
RF Connector Mechanical Tolerances	
Type-N male (85037A)	
Recession of the male center conductor	0.207 to 0.210 in ¹
Precision 7 mm (85037A Option 001)	
Recession of the center conductor ²	0 to 0.003 in
Collet resilience	After you depress the collet, it must spring back out.
Precision 3.5 mm (85037B)	
Recession of the male center conductor	0 to 0.003 in

¹ Because a type-N gage calibration block zeros the gage at a 0.207 inch offset, the gage displays a 0.207 to 0.210 inch offset as 0.000 to 0.003 inches.

² With the center conductor collet removed.

Table 1-4. Recommended Test Equipment

Item	Critical Specifications	Agilent Model or Part Number
Type-N Connector Gage Kit	Required for 85037A No substitute	85054-80011
7 mm Connector Gage Kit	Required for 85037A Option 001 No substitute	85050-80012
3.5 mm Connector Gage Kit	Required for 85037B No substitute	11752-60105
Collet Extractor Tool	Required for 85037A Option 001 No substitute	5060-0370
Synthesized Sweeper	Compatible with 8757D	83620A/30A
Scalar Network Analyzer	No substitute	8757D
Directional Bridge	Compatible with 8757D AC/DC detection	85027A/B/C
Power Meter		436A, 437B or 438A
Calibrated Power Sensor	Type-N Precision 7 mm Precision 3.5 mm	8481A 8481A Option 001 8485A
10 dB Attenuator	Type-N Precision 7 mm Precision 3.5 mm	8491B Option 010 8492A Option 010 8493C Option 010
Calibrated Short	Type-N	11511A
Shielded Open	Type-N	85032-60001
Calibrated Short/Shielded Open	Precision 3.5 mm Precision 7 mm	85037-60001 85021-60001
Adapter	Type-N (f) to BNC (m) Type-N (m) to Type-N (m) 3.5 mm (f) to 3.5 mm (f) Type-N (m) to APC-7 (Option 001 only)	1250-1534 1250-1475 1250-1749 11525A
Torque Wrench	Precision 7 mm 12 in-lb (85037A Option 001) 20 mm 8 in-lb (85037B)	8710-1766 8710-1764

Installation

Safety Considerations

There are no hazardous voltages in this detector.

Initial Inspection

1. Check the shipping container and packaging material for damage.
2. Check that the shipment is complete.
3. Check connector, cable, and detector body for mechanical damage.
4. Check the detector electrically:

Either make a measurement or test to specifications. (See Chapter 3, “Operation” or Chapter 4, “Performance Tests.”)

If any of the following conditions exist, notify your nearest Agilent office:

- incomplete shipment
- mechanical damage or defect
- failed electrical test

If you find damage or signs of stress to the shipping container or the cushioning material, keep them for the carrier’s inspection. Agilent does not wait for a claim settlement before arranging for repair or replacement.

Preparation for Use

Caution

Do not subject the detector to mechanical shock.

Electrostatic Discharge (ESD)

ESD can damage the highly sensitive microcircuits in this device; charges as low as 100 V can destroy a detector.

ESD damage occurs most often as you connect or disconnect a device. Use this detector at a static-safe workstation and wear a grounding strap. *Never* touch the input connector center contacts or the cable contact pins.

Static-Safe Workstation

Figure 2-1 illustrates a static-safe station using two types of ESD protection that you can use either together or separately.

- A conductive table mat and wrist-strap combination.
- A conductive floor mat and heel-strap combination.

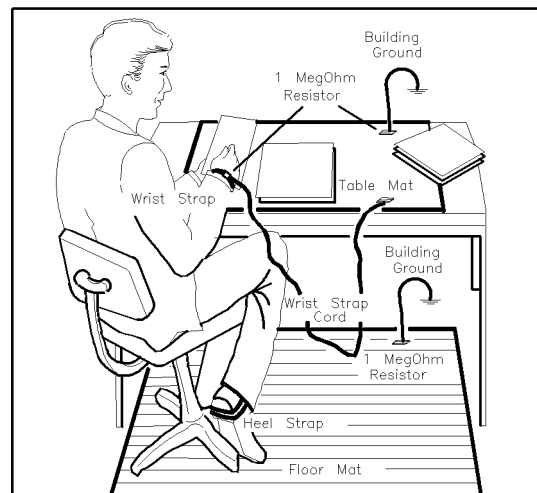

Figure 2-1. Example of a Static-Safe Workstation

Static-Safe Practices

- Before cleaning, inspecting, or making a connection to a static-sensitive device or test port, ground yourself as far as possible from the test port.
- Discharge static electricity from a device before connecting it:

Touch the device briefly (through a resistor of at least 2 M Ω) to either the outer shell of the test port, or another exposed ground. This discharges static electricity and protects test equipment circuitry.

Power Requirements

The scalar network analyzer supplies power for the detector.

Cable Lead Identification

When you use more than one detector, use the coded cable clips (from the cable marker kit) to identify leads; place matching clips on each cable, one at each end.

Mating Connectors

Table 1-3 lists connector mechanical tolerances. *Microwave Connector Care Quick Reference Card* (08510-90360) provides information on the proper maintenance, inspection, and gaging of connectors. Use the appropriate torque wrench. (See Table 1-4.)

Caution

When tightening a connector, do not apply more than the recommended torque value. If you torque the connectors with more pressure than is recommended it can deform the mating surfaces.

Connecting an 85037A/B

Connect a detector to the network analyzer as follows:

1. With the cable plug key downward, insert the DC connector into the analyzer mating connector.
2. To secure the DC connector in the analyzer, turn the *outer* shell clockwise.
3. For a standard detector, connect the RF input by turning the male connector *outer* shell clockwise.
4. For a precision (Option 001) 7 mm connector, refer to Figure 2-2.

<p>To Connect:</p> <ol style="list-style-type: none">1. On one connector, retract the coupling sleeve by turning the coupling nut counterclockwise until the sleeve and nut disengage.2. On the other connector, fully extend the coupling sleeve by turning the coupling nut clockwise. To engage coupling sleeve and coupling nut when the sleeve is fully retracted, press back lightly on the nut while turning it clockwise.3. Push the connectors firmly together, and thread the coupling nut of the connector with retracted sleeve over the extended sleeve.4. Do NOT tighten the other coupling nut since this will tend to loosen the electrical connection.	<p>To Disconnect:</p> <ol style="list-style-type: none">1. Loosen the coupling nut of the connector showing the wider gold band.2. IMPORTANT: Part the connectors carefully to prevent striking the inner conductor contact.  <p>The diagram shows a cross-section of a precision 7 mm connector. It consists of two main parts: a coupling nut on the left and a wider gold band on the right. The coupling nut is shown with a central hole and a flange. The wider gold band is shown with a central hole and a flange. The coupling nut is shown with a wider gold band on its outer surface. The wider gold band is shown with a wider gold band on its outer surface. The diagram is labeled with 'LOOSEN THIS COUPLING NUT TO DISCONNECT' pointing to the coupling nut and 'WIDER GOLD BAND' pointing to the wider gold band.</p>
--	---

Figure 2-2. Using Precision 7 mm Connectors

Mating a Precision 3.5 mm Connector to an SMA Connector

It is possible to mate a precision 3.5 mm connector to an SMA connector, but this is not ideal because the two connectors have slightly different dimensions and mechanical characteristics. Mating a precision 3.5 mm connector to an SMA connector also affects the electrical performance. (See “Electrical Performance”.) Use the following procedure to safely mate 3.5 mm and SMA connectors.

1. Inspect the SMA connector.

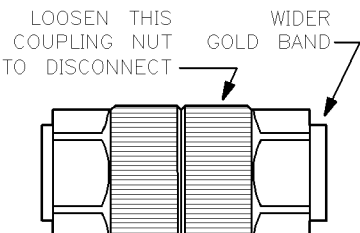
Never mate a precision 3.5 mm connector to an SMA connector in which the solid plastic dielectric protrudes in front of the outer conductor mating plane.

2. Gage both connectors. The SMA connector must meet the precision 3.5 mm connector setback specifications. If not, it will damage the 3.5 mm connector.

In some SMA connectors, the male contact pins are not held securely and are easily pulled out of specification (especially if the female connector contact fingers are tight). Also, some SMA male pins are not true pins, but are the cut-off ends of the center conductor in semi-rigid coaxial cable. In this case, misalignment and burrs are likely to occur.

3. Carefully align the connectors.
4. Push the two connectors together with the male contact pin precisely concentric with the female.
5. Do not twist either connector or device.
6. Turn only the outer male connector nut.
7. Use a 60 N-cm (5 in-lb) torque wrench for the final connection.

If you must make more than a few connections, use a 3.5 mm-to-3.5 mm adapter to protect the 3.5 mm connector.

Electrical Performance. The electrical performance of the junction of two precision 3.5 mm connectors is superior to the junction of either two SMA connectors, or an SMA connector mated to a precision 3.5 mm connector. (See Figure 2-3.)

When you mate an SMA connector with a precision 3.5 mm connector, the connection has a typical mismatch (SWR) of 1.10 at 2 GHz. This mismatch is less than that of two SMA connectors, but is much higher than that of two precision 3.5 mm connectors.

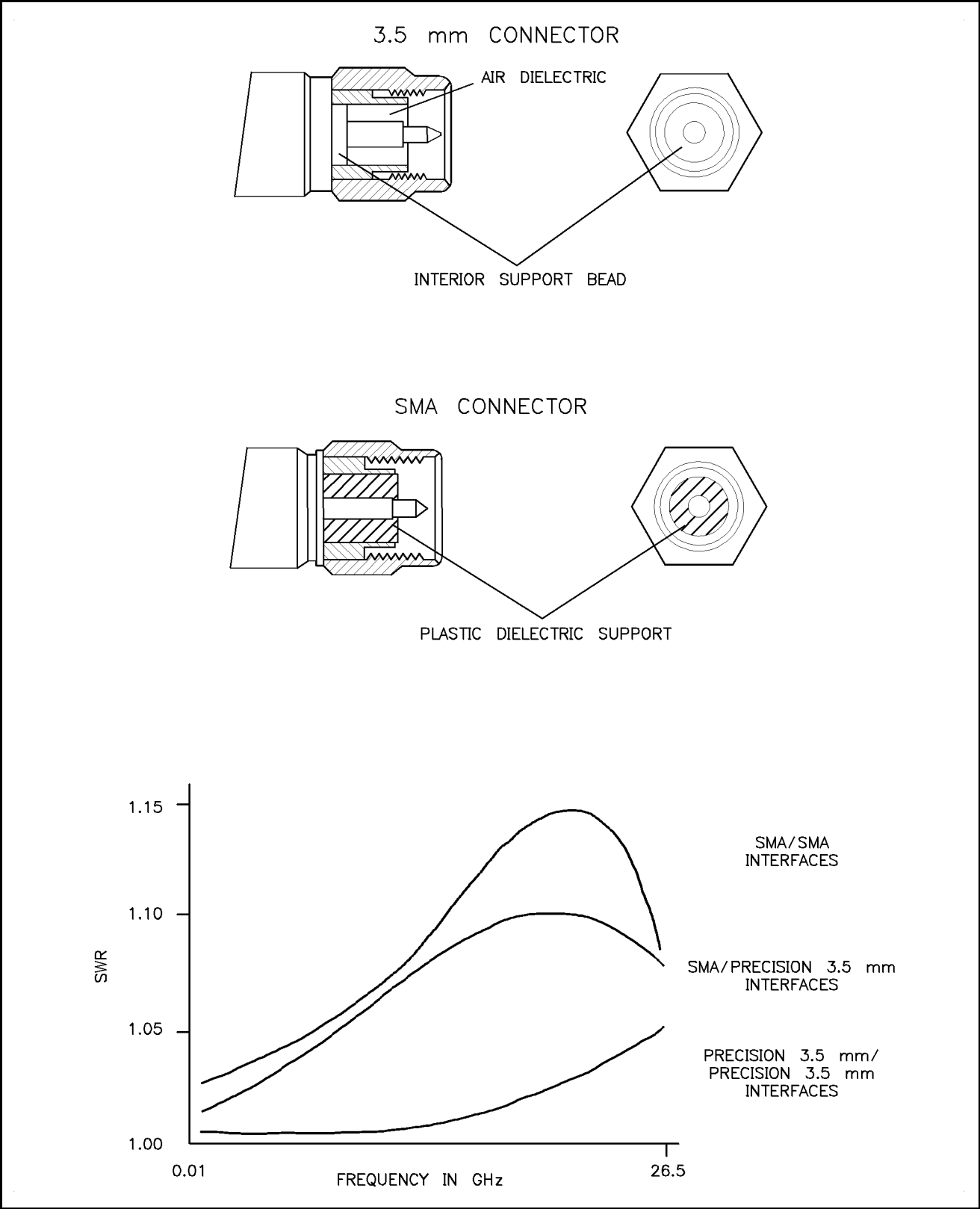

Figure 2-3. SMA and 3.5 mm Connector Cross-Sections and SWR Performance

Operating Environment

Temperature:	0 °C to +55 °C.
Humidity:	Up to 95%. Protect the detector from temperature extremes, which can cause condensation.
Altitude:	Up to 7,620m (25,000 ft).

Storage and Shipment

Environment Store or ship the detectors in environments within the following limits:

Temperature:	-25 °C to +75 °C.
Humidity:	Up to 95%. Protect the detector from temperature extremes which can cause condensation.
Altitude:	Up to 7,620m (25,000 ft).

Packaging Containers and materials identical to those used in factory-packaging are available. Contact your local Agilent office for information. If you package the detector using commercially available material, follow these instructions:

1. Wrap the detector in heavy paper.
2. Use a strong shipping container that has a double-wall carton of at least 350-pound test material.
3. Provide a firm cushion that prevents movement inside the container.
4. Use a 5 to 7 cm (3 to 4 inch) layer of shock-absorbing material around all sides of the detector.
5. Seal the shipping container securely.
6. Mark the shipping container **FRAGILE**.

Returning a Detector for Service

If you ship the detector to a Agilent office or service center fill out a service tag (provided at the back of this manual), and include the following information:

1. Company name and address.

Do not use an address with a P.O. box number because products cannot be returned to a P.O. box.

2. A technical contact person with a complete phone number.
3. The complete model and serial number of the detector.
4. The type of service required (calibration, repair).
5. Any other information, such as failure condition or cause, that could expedite service.

When you make an inquiry, either by mail or by telephone, refer to the detector by both model number and full serial number.

Operation

Operating Theory

The 85037A/B can detect either unmodulated RF signals (DC mode) or square wave amplitude modulated RF signals (AC mode). In either detection mode, the detector provides a 27.778 kHz square wave signal to the analyzer to interpret and display.

AC Detection

In AC detection, an RF or microwave signal is amplitude modulated with a 27.778 kHz square wave. The detector demodulates (envelope detects) and amplifies this signal to produce a 27.778 kHz square wave whose peak-to-peak voltage corresponds to the magnitude of the original RF signal.

DC Detection

DC mode requires no modulation. The detector diode converts the RF signal into DC voltage which is then chopped at a 27.778 kHz rate and amplified. The amplified signal is a signal like that produced by AC detection.

Cautions

Electrostatic discharge (ESD) can damage the highly sensitive microcircuits in this device; charges as low as 100 V can destroy your detector.

ESD damage occurs most often as you connect or disconnect a device. Use this detector at a static-safe workstation and wear a grounding strap. *Never* touch the input connector center contact, or the cable contact pins.

Do *not* exceed the recommended torque specification to tighten a connector because greater surface torque can deform the mating surfaces.

Do *not* apply more than +23 dBm RF CW power or more than ± 10 Vdc to the detector. Higher power/voltage can electrically damage the detector.

Before you connect a cable to the detector, always discharge the cable's center conductor static electricity to instrument-ground.

Do not subject the detector to mechanical shock.

Features

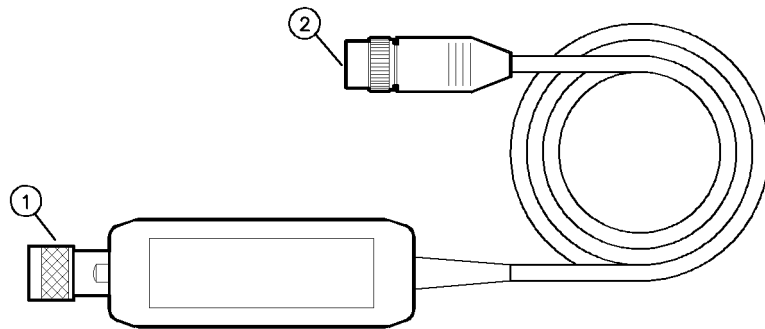

1. RF INPUT CONNECTOR: This connector accepts RF input signal. The RF input connector varies with the detector selected.
2. DC CONNECTOR: This connector supplies the necessary DC voltage for operation of the HP 85037A/B, and feeds the detector output signal to the network analyzer.

Figure 3-1. Detector Features

Connector Torque Values

- Tighten the 85037A type-N connector finger-tight only.
- Tighten the 85037A Option 001 with a torque wrench, part number 8710-1766 set at 13.8 cm-kg (12 in-lb).
- Tighten the 85037B with a torque wrench part number 8710-1764 set at 9.2 cm-kg (8 in-lb).

Operator's Check

See “Characterizing the Detector” in this chapter for a procedure that allows you to quickly check the detector. This procedure can be used as a daily check.

Operating Modes and Specifications

The Agilent 85037 series precision detectors have built-in corrections for both frequency range and dynamic accuracy. These corrections are used to enhance the measurement capability of the detector. The following text explains how the corrections are made. Additional information regarding detector operation is available in the *8757D Scalar Network Analyzer Operating Manual*.

Dynamic Accuracy

The dynamic accuracy and absolute power accuracy of the detector is measured at the factory. Approximately 150 correction constants are then calculated and stored in the EEPROM of each detector. This provides a default correction and is sufficient to guarantee the default dynamic accuracy specifications. To obtain maximum performance, the detector must be connected to the 50 MHz calibrator output of the 8757D Option 002 and then characterized using the built-in correction routine in the 8757D. Once this is done, the detector will meet the enhanced (corrected) specification for dynamic accuracy for both AC and DC measurements. This characterization will remain valid until the detector is unplugged. For optimal performance however, the detector must be recharacterized if its temperature changes by more than ± 5 °C.

Frequency Response

The 85037 uses built-in correction factors to provide the best possible frequency response. The number of correction factors will vary with each detector, but is typically 25. These correction factors are determined at the factory and are stored within the EEPROM of the detector. If the 8757D is used with the system interface, then the analyzer will automatically determine the proper correction factor to use; no user intervention is required. If the 8757 system interface is not being used, then the frequency related correction factors will be determined from the start/stop labels. These labels can be entered into the 8757 by pressing (SYSTEM) LABELS START LABEL (or STOP LABEL) and then entering the start (or stop) frequency.

However, if the frequency the detector sees is different from what is being swept (for example, when using a mixer or multiplier), then the user must manually enter the correct detector frequencies as follows:

1. Press **CAL**.
2. Select **MORE**.
3. Select **DET FREQ**.
4. Select **DET A,B,C or R**.
5. Select **Start Freq** and use the keypad to enter a value.
6. Select **Stop Freq** and use the keypad to enter a value.
7. Select **DET FREQ ON**.

Measurement System Configuration

Figure 3-2 shows a typical measurement setup. AC detection mode, the turn-on state of the 8757D analyzer, does not require any special setup to initiate a measurement. DC detection mode, however, requires that you press specific analyzer keys in the correct order.

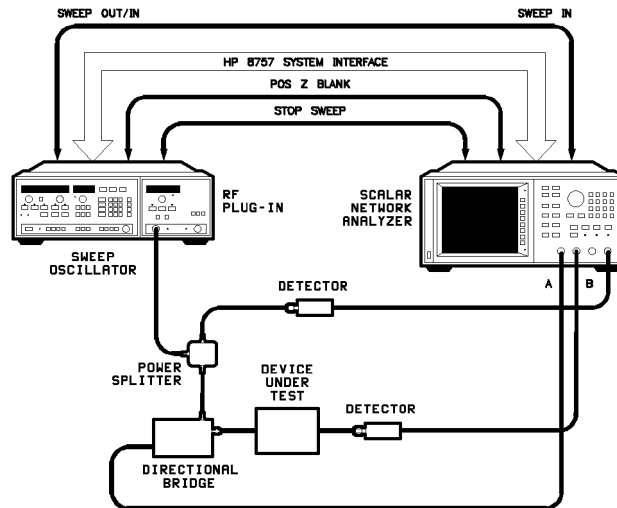

Figure 3-2. Typical Measurement Setup

DC Detection Measurements

DC detection offers absolute power measurement capability and the ability to characterize oscillators and modulation sensitive devices.

Enabling the DC Detection Mode

1. On the analyzer, press **PRESET**.
2. Connect the detector.
3. Enable DC mode:

Press **SYSTEM** and select **MODE DC**.

Selecting the **MODE DC** softkey also turns off the source square wave modulation.

Remember

- You must enable the DC mode to access the DC-specific softkeys.
 - To make DC-mode measurements as shown in Figure 3-2, you must use an 85027 directional bridge capable of both AC and DC detection.
-

Making Accurate DC Measurements

Operation

Before accurate DC measurements can be made, two quick routines must be performed; a DC zero and a dynamic power characterization. (This is referred to as a power calibration on the 8757 and on other annotations.) The DC zero will improve accuracy below -35 dBm. The dynamic characterization will provide the improved (corrected) power accuracy specification on the 8787D Option 002 only. Measurements can be performed without this characterization (such as on instruments without Option 002), however only the default dynamic accuracy specifications of the detector are guaranteed. This characterization includes a DC zero so it is not necessary to perform the zero before performing the characterization.

Zeroing an 85037A/B

When making DC-mode measurements, you must perform a zeroing operation to compensate for the effects of DC drift and temperature fluctuations. This is not required in AC detection. The zeroing operation eliminates small DC voltages present in the detector that would otherwise cause amplitude measurement errors at low power levels (-35 dBm and below). Zeroing also establishes the displayed noise level (the system noise floor) with no RF signal applied. A DC zero should be performed at least once every half-hour once the system has stabilized. A DC zero should be performed more often as the system warms up, or if the temperature is changing. The autozero function is provided to automatically perform DC zeros periodically when the system interface is used.

Note

Before you zero the detector, remove *all* RF signals from the detector input. Even a small RF signal present during zeroing produces measurement errors.

The 8757D analyzer has three types of zeroing:

Autozero **AUTOZRO** turns off the source RF signal output and automatically zeroes the detector.

Repeat Autozero **REPT AZ ON/OFF** automatically repeats autozero at selected intervals.

Manual Zero **MANUAL** is similar to power meter zeroing. First you must either physically remove the detector from the RF signal or turn the RF signal off, then you select **MANUAL** to perform the zero.

Note

See the analyzer documentation for more information on these softkeys.

AC Detection Measurements

AC detection is the preferred method for the majority of measurements as it offers greater sensitivity. It also offers immunity to noise and drift with time and temperature. AC detection amplitude measurements require a modulation envelope. The envelope is provided through a 27.778 kHz square wave amplitude modulation of the RF test signal. Test set connections vary depending on the source. Figure 3-2 illustrates a typical measurement setup with an Agilent 8360 synthesized sweeper supplying the 27.778 kHz modulation.

Making Accurate AC Measurements

Accurate AC measurements depend heavily on the envelope of the amplitude modulated RF signal. In addition, to obtain the specified dynamic accuracy, a characterization of the detector (a power cal) must first be performed. Without this characterization, only the default dynamic accuracy is guaranteed. Performing the characterization will calibrate the detector in *both* AC and DC modes. See “Characterizing the Detector” in this chapter.

The RF signal must be squarewave modulated at a rate within 20 Hz of 27.778 kHz. The amplitude ratio of the on portion to the off portion of the envelope must be at least 30 dB and the ratio of on-time to off-time should be within 5% of 50/50. Most Agilent sources provide this capability. If your 8757D scalar network analyzer is equipped with the Option 002 power calibrator, you can obtain the best power measurement accuracy by following this procedure.

Characterizing the Detector (Performing a Power Calibration)

To obtain the best accuracy, and to meet the “corrected” dynamic accuracy specifications, each detector must be characterized on the 8757D input on which it will be used. The characterization routine simultaneously corrects both AC *and* DC measurements. This routine is also useful as an operator’s check to ensure the detector is operating properly. Only the 8757D with an Option 002 power calibrator have this capability.

Detector characterization begins at +20 dBm and decreases in 1 dB increments down to –35 dBm. To reduce measurement time, power steps are larger than 1 dB at lower power levels. Correction values will be generated over this range if the detector is operational. It will also correct for any loss in the detector up to about 50 dB. For example, let's assume a DC detector has a dynamic range of +20 to –50 dBm. A 30 dB attenuator is then placed on the detector and a characterization is performed. Upon completion, the detector will be characterized from +20 to –20 dBm. Applying a 0 dBm signal to the detector/pad combination will result in a 0 dBm reading; not a –30 dBm reading which is what the detector itself is actually seeing. A loss of more than about 50 dB may result in an error message being displayed on the analyzer. This could occur if the detector is defective or if you simply forgot to connect the detector under test to the Power Cal Output of the 8757D.

Upon completion of this routine, the dynamic range of the detector will be displayed; verify that it is correct for the current detection mode, taking into account any attenuation due to added pads or other devices, or due to inherent loss, such as in a directional bridge which typically has 12.5 dB of loss.

To characterize the detector (perform a power cal), connect the detector to the desired input of the 8757D. Connect the RF input of the detector to the calibrator output. Make sure the analyzer has been on and the detector connected for at least 30 minutes.

1. Press **CAL**.
2. Select **MORE**.
3. Select **POWER CAL**.
4. Select **DET A,B,C or R**.
5. Select **START CAL**.

A complete characterization for one detector takes about 60 seconds. Once characterized, do *not* unplug the detector from the analyzer or you will have to perform another characterization. This is because the 8757 automatically recalibrates itself when it senses a detector has been removed or connected to the detector inputs. However, the analyzer *can* be turned off and on again without losing this information. Perform the characterization at least once per day and more often if the temperature varies by more than ± 5 °C.

Performance Tests

Introduction

Use the procedures in this chapter to test the detector's electrical performance to the specifications listed in Chapter 1. None of these tests require access to the detector's interior. To completely test each detector, three tests are required:

1. return loss
2. dynamic accuracy (AC and DC uncorrected)
3. frequency response

Equipment Required

Preceding each test is an equipment table that lists which equipment you will need for that particular test. You may substitute any equipment that meets the indicated critical specifications. Refer to Table 1-4.

Note

Before you perform a performance test, gage the input connector on the detector and enter the results in the test record at the end of "Performance Tests."

Return Loss at a Nominal -10 dBm

Description The return loss of the 85037 can be measured using the test system described in this procedure. The test setup is calibrated using an open/short to minimize frequency response and phasing errors. Then the detector under test (DUT) is connected to the *test port* of the bridge, and its return loss is measured on the 8757D.

The three main sources of error in these measurements come from:

1. bridge directivity
2. source match of the bridge
3. dynamic accuracy of the 8757D

The first two vary with frequency while dynamic accuracy varies with the measured return loss amplitude. Use the corresponding, connector-compatible Agilent directional bridge, Agilent 85027/A/B or C.

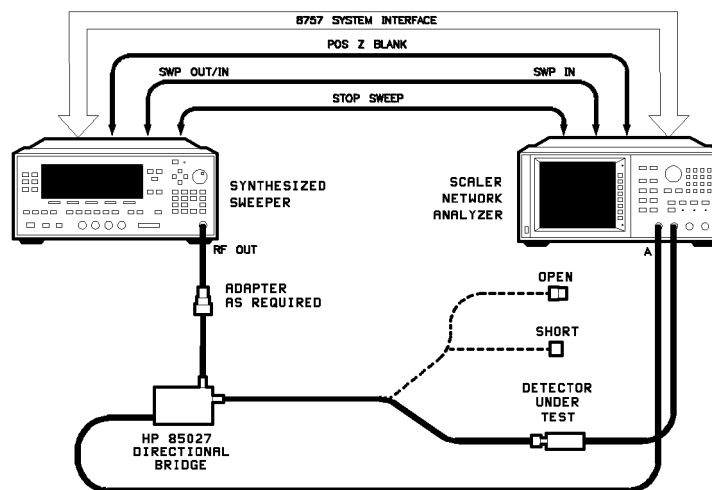

Figure 4-1. Return Loss Setup

Table 4-1. Return Loss Equipment Table

Equipment Common to all Agilent Detectors	
Scalar Network Analyzer	8757D
8360 Series Synthesized Sweeper	83620A/30A
Additional Equipment Required for 85037A	
Directional Bridge	85027C
Shielded Open	Part Number 85032-60001
Short	Agilent 11512A
Adapter Type-N (m) to 3.5 mm (f)	Part Number 1250-1744
Additional Equipment Required for 85037A Option 001	
Directional Bridge	85027A
Calibrated Open/Short	Part Number 85021-60001
Adapter Type-N (m) to 3.5 mm (f)	Part Number 1250-1744
Additional Equipment Required for 85037B	
Directional Bridge	85027B
Calibrated Open/Short	Part Number 85037-60001

Procedure

1. Connect the equipment as shown in Figure 4-1, with nothing connected to the bridge *test port*.

On the 8757D:

Press **PRESET**.

Press Channel **2** **2** (Pressing twice turns channel 2 off).

Allow 30 minutes for warmup.

2. Reset the stop frequency on the source, and if necessary and set the power:

For the 85037A:

On the 83620A source:

Press **STOP** **18** **GHz**.

Press **POWER LEVEL** **-3** **dBm**.

For the 85037B:

It is *not* necessary to reset the stop frequency on the Agilent 83630A source as it stops automatically at 26.5 GHz.

3. Calibrate the test setup.

Press Function **CAL**.

Select **SHORT/OPEN**. Follow the directions (prompts) appearing on the CRT.

Connect the short to the *test port* of the bridge.

Select **STORE SHORT**.

Remove the short.

Connect the open to the *test port* of the bridge.
Select **STORE OPEN**.

Remove the open.

The CRT will display:
SHORT/OPEN CAL SAVED IN CH1 MEM.

Press Function **DISPLAY**.

Select **MEAS-MEM**.

4. On the 8757D:

Connect the detector under test to the *test port* of the bridge.

Press Function **SCALE** **5** **dB**.

Press **CURSOR**. Use the cursor to find the highest trace value (the worst case measurement), in each specification range.
Write each value in the test record.

Note

If more frequency resolution is needed at the low end of the frequency range, repeat the preceding procedure using a stop frequency of 50 MHz.

This completes the procedure for measuring return loss.

Frequency Response at a Nominal -10 dBm

Description The frequency response of the 85037A/B detector is specified as the maximum deviation from a constant input signal of -10 dBm, as measured over the specified frequency range. To simplify the measurement procedure, frequency response is measured with a nominal -10 dBm signal applied. First, the source is characterized for frequency response using a calibrated power meter/sensor combination. Second, the DUT is characterized. Finally, a point-by-point difference is computed, plotted, and compared to the specification window. The manual test described in this procedure has an approximate root sum of the squares (RSS) uncertainty ranging up to ± 0.25 dB. This implies that a “good” detector, well within the limits of its specifications, *could* measure out of specification. This measurement is only an indication of the detector’s response within these limits. If greater measurement accuracy is desired, a test system that minimizes the sources of measurement uncertainty will be required.

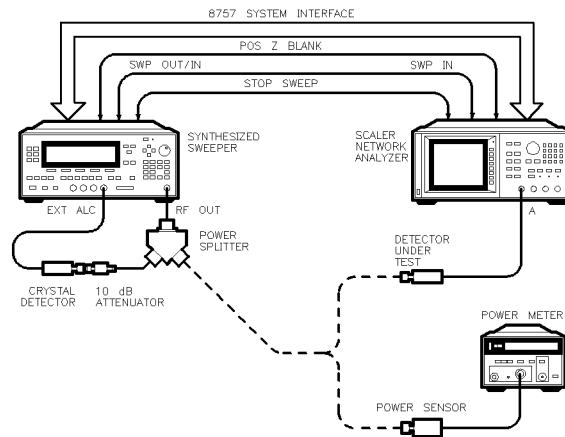

wc62ab

Figure 4-2. Frequency Response Test Setup

Table 4-2. Frequency Response Equipment Table

Equipment Common to All Agilent Detectors	
Scalar Network Analyzer	8757D
8360 Series Synthesized Sweeper	83620A/30A
Power Meter	436A/437B/438A
Additional Equipment Required for Agilent 85037A	
Power Splitter	11667A
Power Meter	436A/437B/438A
Calibrated Sensor	8481A
10 dB Attenuator	8491B Option 010
Crystal Detector	8474B
Additional Equipment Required for Agilent 85037A Option 001	
Power Splitter	11667A Opt 002
Power Meter	436A/437B/438A
Calibrated Sensor	8481A Option 001
10 dB Attenuator	8492A Option 010
Crystal Detector	8474A
Additional Equipment Required for Agilent 85037B	
Power Splitter	11667B
Power Meter	436A/437B/438A
Calibrated Sensor	8485A
10 dB Attenuator	8493C Option 010
Crystal Detector	8473D

Procedure

Configuring the System

1. Connect the equipment as shown in Figure 4-2, with nothing connected to the open end of the power splitter.

Turn on all equipment.

Allow 30 minutes for warmup.

2. On the power meter:

Press **[dBm]** mode.

Zero and calibrate the power meter. If you are unsure of how to do this, refer to the power meter operating and service manual.

[Range Hold] and **[Power Ref]** should remain off.

Set the *Cal Factor %* on the power meter to the value indicated for 50 MHz on the power sensor *Cal Factor Chart*.

3. On the 8757D:

Preset the analyzer, turn channel 2 off, and select the detector mode for DC:

Press **[PRESET]**.

Press Channel **[2]** **[2]** (Pressing twice turns Channel 2 off).

Press Instrument State **SYSTEM**.

Select **MODE DC**.

4. On the source:

Press **CW** **50** **MHz**.

Connect the power meter/sensor to the output of the splitter.

Press **ALC** **Ext Det** **MORE** **Coupling Factor** **10** **dB**.

Press **POWER LEVEL** **-10** **dBm** and, if necessary, adjust the power level for a power meter reading within ± 0.05 dB of -10 dBm.

Do not readjust the power level for the remainder of this test.

Measuring the Source

5. On the source:

Press **CW** and enter the test frequencies as shown on the work sheet.

For example: **CW** **.01** **GHz**.

6. Using the Cal Factor Chart on the Power Sensor:

- Set the *Cal Factor %* on the power meter to the value indicated for the test frequency as needed. (Use the nearest frequency value.)
- Note the reading on the power meter.
- Record this value onto the worksheet Table 4-3 under the "Source Power" column.

7. Repeat steps 5 and 6 using, at minimum, the test frequencies noted on the work sheet.

8. Disconnect the power meter/sensor.

Measuring the Detector

9. With the detector still disconnected from the source, zero the detector:

Press **CAL** on the 8757D.

Select **DC DET ZERO**.

Select **AUTOZERO**.

When the zero is complete, the display will indicate:

AUTO ZERO COMPLETE.

10. Connect the detector to the power splitter.

On the 8757D:

Press Function **CURSOR** to turn the cursor on.

11. On the source:

Press **CW** and enter the first test frequency. Remember to use only the test frequencies used in steps 5 through 7.

12. Note and record on the worksheet (under the “Measured Power” column) the value indicated by the 8757D cursor display.

13. Repeat this step until all of the same frequency points have been measured.

Computing the Maximum Error

14. Using the values recorded in steps 6 and 12, subtract the value in step 6 from the value in step 12 for each of the frequencies as shown on the worksheet.

Now use these values to plot a point to point variation curve on the graph on the next page. The peak to peak variations determine the frequency response of the detector. Record this result on the test record.

This completes the procedure for measuring frequency response.

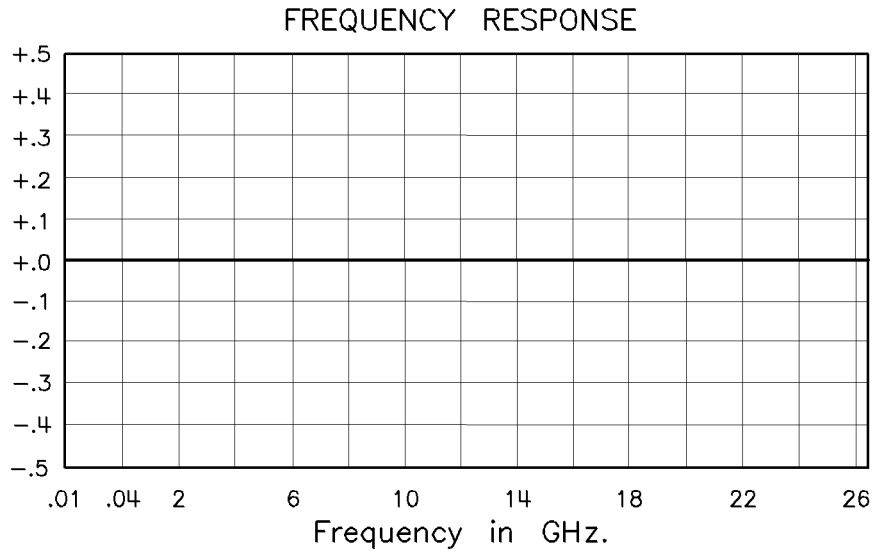

Figure 4-3. Frequency Response Graph

Table 4-3. Worksheet

Recommended Test Frequencies			
Frequency in GHz	Measured Power (dBm)	Source Power (dBm)	Meas Power minus Source Power (dB)
0.01	_____	_____	_____
0.04	_____	_____	_____
0.10	_____	_____	_____
2	_____	_____	_____
6	_____	_____	_____
10	_____	_____	_____
14	_____	_____	_____
16	_____	_____	_____
18	_____	_____	_____
20	_____	_____	_____
22	_____	_____	_____
24	_____	_____	_____
26.5	_____	_____	_____

Dynamic Power Accuracy

Description The dynamic power accuracy of the 85037A/B is dependent upon the raw (uncorrected) response of the detector, the correction routine of the 8757D analyzer, and the accuracy of the 8757D Option 002 calibrator. The accuracy of the calibrator is assumed to be within specifications. This can be checked by following the performance test procedure in the 8757D manual. The correction routine is fixed and cannot vary, so it is also assumed to be accurate. The high accuracy of the 85037A/B is only guaranteed after performing the built-in characterization routine (a power cal) in the 8757D. Once this is done, performing any dynamic accuracy tests using the same 8757D calibrator is ineffectual because the only error that will be seen will be due to measurement repeatability and any possible temperature drift. Therefore, to verify the dynamic accuracy of the 85037A/B, only the raw, uncorrected performance is measured. Once this has been verified, the corrected dynamic accuracy, by design, must be within specification. Independent verification of both corrected and uncorrected specifications can be performed by using either of the two alternative setups shown in Figure 4-5 or Figure 4-6. Testing of the raw dynamic accuracy performance is the only test required. The manual test procedure follows.

- Procedure**
1. Connect the equipment as shown in Figure 4-4. If the sweeper is on, turn it off.
 2. Allow equipment to warm up for 30 minutes.
 3. Disconnect the detector.
 4. Press **PRESET**.
 5. Reconnect the detector to input A, this forces default correction.
 6. Press Channel **2 2** (Pressing twice turns Channel 2 off).
 7. Press **SYSTEM**.
 8. Select **MORE SWEEP MODE CW ON**.
 9. Press **CAL MORE DET OFFSET MEASURE DET OFS DET A 0 dBm START MEAS**. Read the offset value. Note this number as the reference value.
 10. Press **CAL PRIOR MENU 19 dBm START MEAS**.
 11. Read the offset value shown on the 8757D and subtract from this the reference value in step 9. Record the results on the test record card under Dynamic Accuracy AC Mode.
 12. Repeat steps 10 and 11 at the power levels shown on the test record.

13. Verify the noise floor in AC mode.
Press: **AVG** **AVG ON** **CURSOR**
and record the average noise floor as displayed by the cursor reading.
14. Press **PRESET** **SYSTEM** **MODE DC**.
15. Repeat steps 6 through 12 for DC mode. The detector should be rezeroed between the -30 and -40 dBm steps.

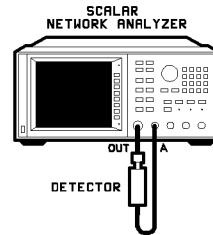

Figure 4-4. Dynamic Power Accuracy Test Setup

First Alternate Dynamic Power Accuracy

Description

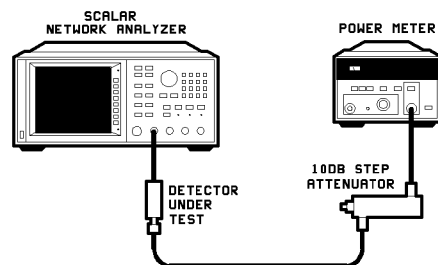

Figure 4-5. First Alternate Dynamic Power Accuracy Test Setup

This setup is for performing independent verification of dynamic accuracy in 10 dB increments up to 0 dBm in DC mode.

Second Alternate Dynamic Power Accuracy

Description

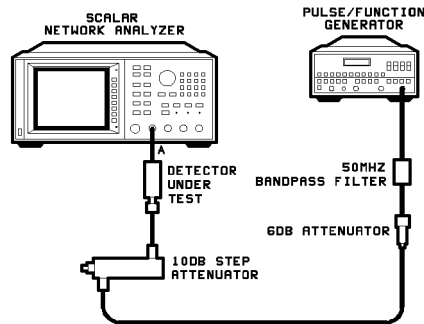

Figure 4-6. Second Alternate Dynamic Power Accuracy Test Setup

This setup is for performing independent verification of dynamic accuracy in 10 dB increments up to +20 dBm in DC mode.

Table 4-4. Additional Equipment

Function Generator	Agilent 8116A
50 MHz Bandpass Filter	08757-80027

Procedure

1. Set the 8757D for CW, DC mode, cursor on.
2. Set the step attenuator to 20 dB.
3. Adjust the 8116 for a 50 MHz sinewave and adjust the amplitude for a cursor reading of 0.0 dBm.
4. Adjust the step attenuator in 10 dB steps and compare the 8757D cursor reading with the calculated applied power determined by the calibrated step attenuator. The 20 dB step on the step attenuator becomes the reference. The other steps are relative to this 20 dB value.
5. The detector should be rezeroed between the -30 and -40 dBm steps.

Table 4-5. Test Record for 85037A

Test Facility _____	Report Number _____
_____	Date _____
_____	Customer _____
_____	Tested by _____
Model _____	Ambient temperature _____ °C
Serial Number _____	Relative humidity _____ %
Options _____	
Special Notes	

Table 4-5. Test Record for 85037A (2 of 3)

Model _____	Report Number _____	Date _____	
Test Equipment Used	Model Number	Trace Number	Cal Due Date
1. _____	_____	_____	_____
2. _____	_____	_____	_____
3. _____	_____	_____	_____
4. _____	_____	_____	_____
5. _____	_____	_____	_____
6. _____	_____	_____	_____
7. _____	_____	_____	_____
8. _____	_____	_____	_____

Table 4-5. Test Record for 85037A (3 of 3)

Serial Number:	Report Number:		Date:
Test Description	Specification	Measured Results	Measurement Uncertainty ¹
Return Loss at a Nominal –10 dBm			
0.01 to 0.04 GHz	10 dB	_____	±1.0 dB
0.04 to 18 GHz	20 dB	_____	±2.4 dB
Frequency Response at a Nominal –10 dBm			
0.01 to 0.04 GHz	±0.30 dB	_____	±0.18 dB
0.04 to 18 GHz	±0.20 dB	_____	±0.25 dB
Dynamic Power Accuracy			
AC Mode uncorrected			
+19 dBm	±0.4 dB	_____	±0.2 dB
+10 dBm	±0.4 dB	_____	±0.13 dB
–30 dBm	±0.4 dB	_____	±0.22 dB
–40 dBm	±0.8 dB	_____	±0.30 dB
–50 dBm	±1.3 dB	_____	±0.36 dB
Noise Floor	≥–55 dBm	_____	
Dynamic Power Accuracy			
DC Mode uncorrected			
+19 dBm	±0.4 dB	_____	±0.2 dB
+10 dBm	±0.4 dB	_____	±0.13 dB
–30 dBm	±0.4 dB	_____	±0.22 dB
–40 dBm	±0.8 dB	_____	±0.3 dB
–50 dBm	±1.3 dB	_____	±0.36 dB

¹ Using the equipment and procedures documented in this manual.

Table 4-6. Test Record for 85037A Option 001

Test Facility _____	Report Number _____
_____	Date _____
_____	Customer _____
_____	Tested by _____
Model _____	Ambient temperature _____ °C
Serial Number _____	Relative humidity _____ %
Options _____	
Special Notes	

Table 4-6. Test Record for 85037A Option 001 (2 of 3)

Model _____	Report Number _____	Date _____	
Test Equipment Used	Model Number	Trace Number	Cal Due Date
1. _____	_____	_____	_____
2. _____	_____	_____	_____
3. _____	_____	_____	_____
4. _____	_____	_____	_____
5. _____	_____	_____	_____
6. _____	_____	_____	_____
7. _____	_____	_____	_____
8. _____	_____	_____	_____

Table 4-6. Test Record for 85037A Option 001 (3 of 3)

Serial Number:	Report Number:		Date:
Test Description	Specification	Measured Results	Measurement Uncertainty ¹
Return Loss at a Nominal –10 dBm			
0.01 to 0.04 GHz	10 dB	_____	±.7 dB
0.04 to 18 GHz	20 dB	_____	±1.4 dB
Frequency Response at a Nominal –10 dBm			
0.01 to 0.04 GHz	±0.30 dB	_____	±0.18 dB
0.04 to 18 GHz	±0.20 dB	_____	±0.25 dB
Dynamic Power Accuracy			
AC Mode uncorrected			
+19 dBm	±0.4 dB	_____	±0.2 dB
+10 dBm	±0.4 dB	_____	±0.13 dB
–30 dBm	±0.4 dB	_____	±0.22 dB
–40 dBm	±0.8 dB	_____	±0.3 dB
–50 dBm	±1.3 dB	_____	±0.36 dB
Noise Floor	≥–55 dBm	_____	
Dynamic Power Accuracy			
DC Mode uncorrected			
+19 dBm	±0.4 dB	_____	±0.2 dB
+10 dBm	±0.4 dB	_____	±0.13 dB
–30 dBm	±0.4 dB	_____	±0.22 dB
–40 dBm	±0.8 dB	_____	±0.3 dB
–50 dBm	±1.3 dB	_____	±0.36 dB

¹ Using the equipment and procedures documented in this manual.

Table 4-7. Test Record for 85037B

Test Facility _____	Report Number _____
_____	Date _____
_____	Customer _____
_____	Tested by _____
Model _____	Ambient temperature _____ °C
Serial Number _____	Relative humidity _____ %
Options _____	
Special Notes	

Table 4-7. Test Record for 85037B (2 of 3)

Model _____	Report Number _____	Date _____	
Test Equipment Used	Model Number	Trace Number	Cal Due Date
1. _____	_____	_____	_____
2. _____	_____	_____	_____
3. _____	_____	_____	_____
4. _____	_____	_____	_____
5. _____	_____	_____	_____
6. _____	_____	_____	_____
7. _____	_____	_____	_____
8. _____	_____	_____	_____

Table 4-7. Test Record for 85037B (3 of 3)

Serial Number:	Report Number:		Date:
Test Description	Specification	Measured Results	Measurement Uncertainty ¹
Return Loss at a Nominal –10 dBm			
0.01 to 0.04 GHz	10 dB	_____	±0.7 dB
0.04 to 18 GHz	20 dB	_____	±1.4 dB
18 GHz to 26.5 GHz	18 dB	_____	±2.0 dB
Frequency Response at a Nominal –10 dBm			
0.01 to 0.04 GHz	±0.30 dB	_____	±0.18 dB
0.04 to 18 GHz	±0.20 dB	_____	±0.25 dB
18 GHz to 26.5 GHz	±0.30 dB	_____	±0.3 dB
Dynamic Power Accuracy			
AC Mode uncorrected			
+19 dBm	± 0.4 dB	_____	±0.2 dB
+10 dBm	± 0.4 dB	_____	±0.13 dB
–30 dBm	± 0.4 dB	_____	±0.22 dB
–40 dBm	± 0.8 dB	_____	±0.3 dB
–50 dBm	± 1.3 dB	_____	±0.36 dB
Noise Floor	≥ –55 dBm	_____	
Dynamic Power Accuracy			
DC Mode uncorrected			
+19 dBm	± 0.4 dB	_____	±0.2 dB
+10 dBm	± 0.4 dB	_____	±0.13 dB
0 dBm	+ 0.4 dB	_____	±0.22 dB
–30 dBm	± 0.4 dB	_____	±0.22 dB
–40 dBm	± 0.8 dB	_____	±0.3 dB
–50 dBm	± 1.3 dB	_____	±0.36 dB

¹ Using the equipment and procedures documented in this manual.

Adjustments

Introduction

Two adjustments can be performed on the 85037A/B.

1. coarse zero adjustment
2. feedthrough nulling adjustment

Normally these two adjustments do not need to be performed. They should only be performed if the zeroing routine fails.

Before attempting any adjustments:

- Turn on all equipment and allow a minimum of 30 minutes warmup time.
- Note that the adjustments are interactive and *must* be performed in the order given.

Coarse Zero Adjustment

Description The coarse zero adjustment centers the detector's DC preamp input offset voltage within the built-in automatic zero routine's range. This is accomplished by adjusting for the lowest overall indication of noise on the 8757D. When the level is minimized, it indicates that the range has been properly centered. Remove the detector's outer covers and metal housing to allow access for making the adjustments. (Refer to "Removing the Covers" at the beginning of Chapter 7, "Service.")

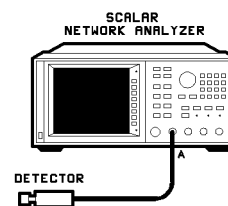

Figure 5-1. Coarse Zero/Feedthrough Nulling Adjustment

Equipment: 8757D scalar network analyzer

- Procedure**
1. Connect the equipment as shown in Figure 5-1 with no input to the detector.
 2. Press **PRESET**.
 3. Press **SYSTEM MORE SERVICE A4 ADC MORE CHANNEL VOLTS CHANV LOGGER**.
 4. Locate the single-turn potentiometer on bottom side of the board.
While viewing the **DATA READING** for **INPUT A**, adjust the coarse zero potentiometer (the single turn pot) for the most negative reading (typically about -5 V). See Figure 5-2.

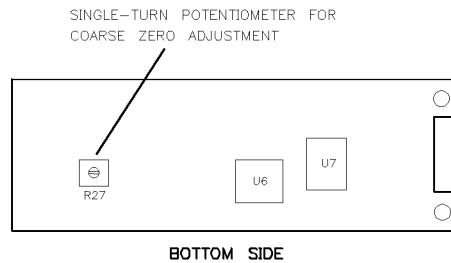

Figure 5-2. Coarse Zero Adjustment

Feedthrough Nulling Adjustment

Description

The feedthrough nulling is adjusted for best DC accuracy below -45 dBm. This is accomplished by adjusting for the *highest* overall indication of noise on the 8757D. When the level of noise is maximized, it indicates that the feedthrough is nulled.
Equipment: 8757D scalar network analyzer

Procedure

Perform the following steps in order.

Connect the equipment as shown in Figure 5-1.

On the 8757D:

1. Press **PRESET**.
2. Press Channel **2** **2** (Pressing twice turns Channel 2 off).
3. Press **SYSTEM** **MORE** **SWEEP MODE** **CW ON** to place the 8757D in CW mode.
4. Press **SYSTEM** **MODE DC**.
5. Press **SPCL** **SMOOTH ON**.
6. Press **SCALE** **5** **dB**.
7. If necessary, use the arrows keys to move up or down to set the reference line to the center of the screen. (This will be 4 divisions up from the bottom of the CRT screen.)
8. Press **REF** **REF POSN**.
9. Press **CURSOR** **CRSR → REF LVL**.

10. Press **CAL** **DC DET ZERO** **MANUAL**. The display indicates: REMOVE RF FROM DC DETECTORS. If you have connected the detector to an RF output, disconnect it.
11. Press **CONT**.

When the routine is complete the display indicates: MANUAL ZERO COMPLETED.

12. Locate the Feedthrough Null multi-turn potentiometer which is on the top side of the PC board, (the same side as the cable wires). Adjust it one half turn (either direction). See Figure 5-3.
13. Repeat steps 9 through 12 until turning the Feedthrough Null potentiometer in either direction will only *decrease* the displayed noise. If the overall noise level is less (lower on the screen) than the beginning value noted, reverse the direction of adjustment. Continue adjusting until the noise level displayed is *maximized*.

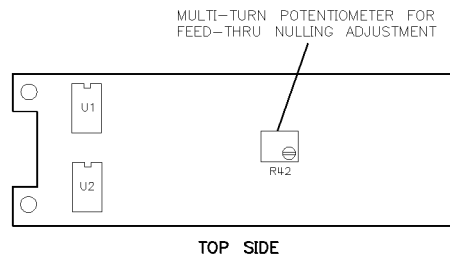

Figure 5-3. Feedthrough Nulling Adjustment

Replaceable Parts

Introduction

This section provides replaceable parts and ordering information.

Ordering Parts

To order a part listed in the replaceable parts Table 6-2, quote the Agilent part number, indicate the quantity required and address the order to your nearest Agilent office.

To request information on a part that is not listed in the replaceable parts table, include the instrument model number and a description of the part and its function. Address the inquiry to the nearest Agilent office.

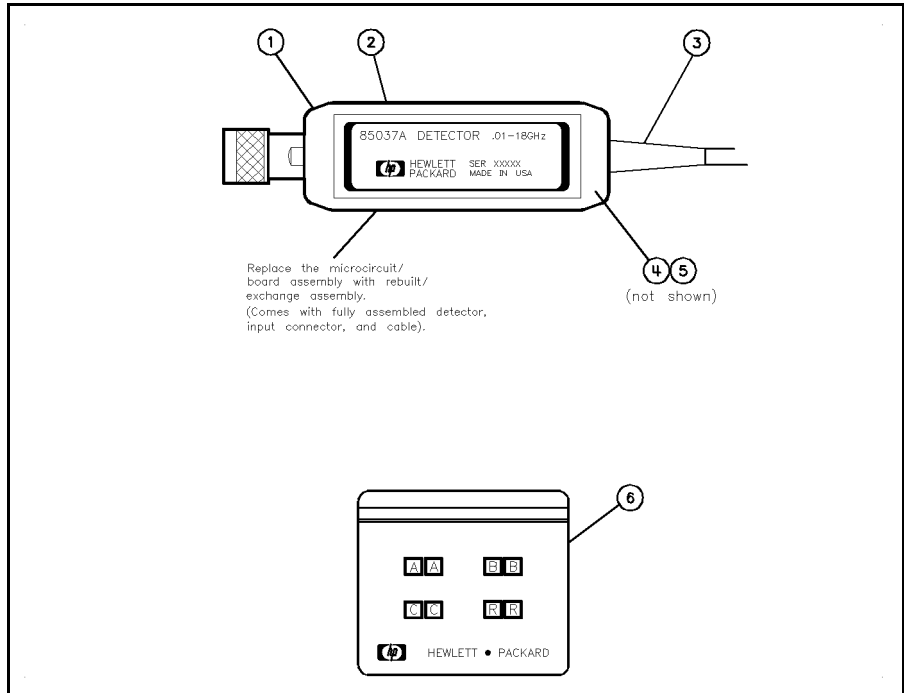

Figure 6-1. Detectors and Cable Marker Kit

Table 6-1. Miscellaneous Parts

Item #	Description and Quantity	Agilent Part Number
1	Plastic half-body cover (2)	85025-40006
2	Label: warning max input (1)	85037-80003
	Label: electrostatic sensitive (1)	85037-80002
3	Cable assembly (1)	85025-60003
4	Screw M2.5 x 0.45; 4 mm-LG (2)	0515-0972
5	Lock washer 2.5 mm (2)	2190-0583
6	Cable marker kit (1)	5061-1044

Table 6-2. Replaceable Parts and Accessories

Part	Description	Agilent Model or Part Number
Rebuilt/Exchange Assemblies		
85037A	Type-N	85037-69006
85037A Option 001	7 mm	85037-69007
85037B	3.5 mm	85037-69008
Accessories		
Connector Gage Kits	Type-N	85054-80011
	7 mm	85050-80012
	3.5 mm	11752-60106
Collet Extractor Tool	For 85037A Option 001	5060-0370
Adapters	Type-N (f) to BNC (m)	1250-1534
	Type-N (m) to Type-N (m)	1250-1475
	3.5 mm (f) to 3.5 mm (f)	1250-1749
	Type-N (m) to APC-7 (Option 001 only)	11525A
	APC-3.5 (f) to N (m)	1250-1744
Extension Cables	7.6 meter (25 foot)	11679A
	61 meter (200 foot)	11679B
Connector Care Quick Reference Card		08510-90360

Use this fast, efficient, economical method to keep your Hewlett-Packard instrument in service.

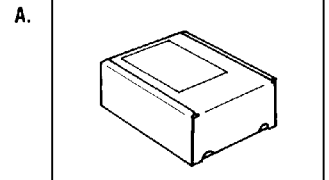
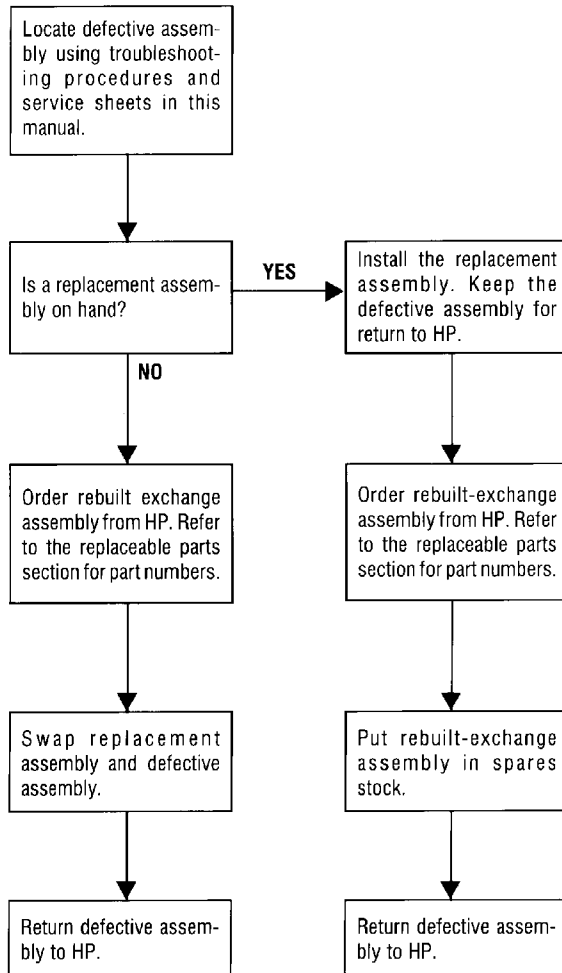

Rebuilt-exchange assemblies are shipped individually in boxes like this. In addition to the circuit assembly, the box contains:
Exchange assembly failure report
Return address label

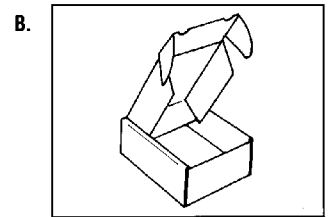

Open box carefully - it will be used to return defective assembly to HP. Complete failure report. Place it and defective assembly in box. Be sure to remove enclosed return address label.

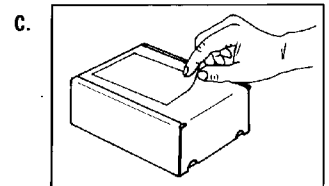

Seal box with tape. Inside U.S.A.*, stick preprinted return address label over label already on box, and return box to HP. Outside U.S.A., do not use address label; instead address box to the nearest HP office.

*HP pays postage on boxes mailed in U.S.A.

Figure 6-2. Module Exchange Program

By internet, phone, or fax, get assistance with all your test & measurement needs.

Table 6-3. Contacting Agilent

Online Assistance: www.agilent.com/find/assist

United States (tel) 1 800 452 4844	Japan (tel) (81) 426 56 7832 (fax) (81) 426 56 7840	New Zealand (tel) 0 800 738 378 (fax) 64 4 495 8950
Canada (tel) 1 877 894 4414 (fax) (905) 206 4120	Latin America (tel) (305) 269 7500 (fax) (305) 269 7599	Asia Pacific (tel) (852) 3197 7777 (fax) (852) 2506 9284
Europe (tel) (31 20) 547 2323 (fax) (31 20) 547 2390	Australia (tel) 1 800 629 485 (fax) (61 3) 9210 5947	

Service

Caution

This product is susceptible to damage from electrostatic discharge (ESD). When you perform any of the following procedures, wear a grounded static-strap and work at a static-safe workstation.

Error Messages

The message `EEPROM read failed -- A (B, C or R)` Indicates that the EEPROM calibration constants are either corrupted or unable to be read from the detector. The problem could be in either the detector or the 8757D. Try another detector to isolate the cause. If the detector appears to be the cause of the problem, then the detector needs to have the calibration constants regenerated at the factory. Refer to “Returning a Detector for Service” in Chapter 2, “Installation.”

Repair

These detectors have only one repairable item:

- The cable assembly.

If the detector fails electrically, order an exchange detector:

1. See the Replaceable parts, Table 6-2, for the part number that matches the model that you are replacing:

85037A

85037A Option 001 or

85037B.

2. Follow “The Module Exchange Program” instructions in Figure 6-2.

Remember

To receive exchange credit, you *must* return the failed assembly to Agilent in the exchange assembly box.

Repair

Replacing the Detector

1. Remove the plastic covers from the existing detector. (See “Removing the Covers.”)
2. Install the covers on the replacement detector.
3. Perform an operator’s check. (See “Operator’s Check” in Chapter 3.)
4. If the replacement is a restored exchange detector, return the defective detector using the packing material supplied.

Removing the Covers

1. Place the detector with its narrow side on a flat surface, with the RF connector facing away from you. (See Figure 7-1.)
2. Holding the sides of the detector near the cable end, insert a small flat-blade screwdriver with a blade no greater than 3.5 mm (1/8 in) between the side label and the raised edge. (See Figure 7-1.)

Make sure you insert the screwdriver as far forward on the detector as possible.
3. Rotate the screwdriver approximately 90°, until the cover snaps apart.
4. Repeat steps 2 and 3, inserting the screwdriver approximately 2/3 of the way toward the cable end of the detector. (See the point shown in Figure 7-1.)
5. Separate the plastic shell halves. If the cover does not separate easily, repeat steps 2 through 4 on the other side of the detector. (See Figure 7-1.)
6. To attach the covers to a replacement detector, snap the halves together.

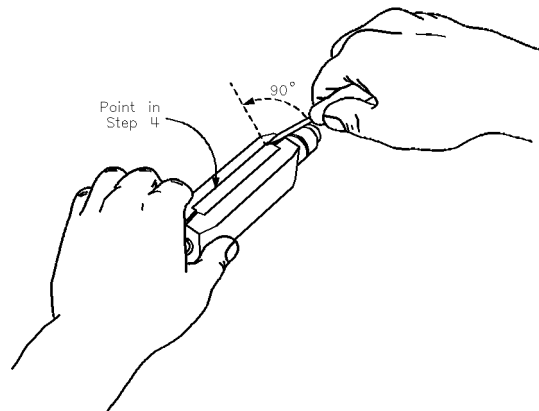

Figure 7-1. Removing the Detector Covers

**Replacing the Cable
Assembly (W1)**

1. Remove the plastic covers from the detector. (See “Removing the Covers.”)
2. Remove the two screws at the cable end of the metal housing.
3. Slide the metal housing away from the RF connector, completely exposing the printed circuit (PC) assembly.
4. Unsolder all cable wires from the PC assembly.
5. With the PC assembly facing up, carefully secure the detector frame in a vice. Do not grip the PC assembly.

Caution

Do not over-tighten the vice; you can bend the frame.

6. Using a 7/16 inch open-ended wrench, unscrew the cable hex nut.
7. Remove the old cable assembly.
8. Remove the metal housing from the cable.
9. Carefully slide the metal housing onto the new cable assembly, making sure that you do not cover the adjustment potentiometers.
10. Solder the new cable wires to the PC assembly. (Refer to Figure 7-2.)
11. Ensure that all cable wires are securely connected to the assembly.
12. Slide the metal housing over the PC assembly.
13. Using the screws removed in step 2, secure the metal housing to the frame.
14. Snap the covers back on.

Repair

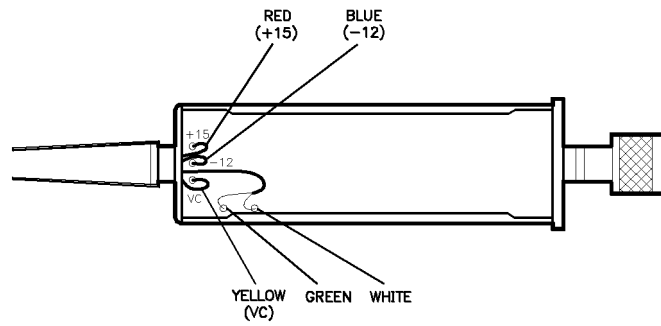

Figure 7-2. Cable Connections

Caring for Connectors

This appendix provides a brief introduction to the fundamentals of proper connector care, as important to good measurements as proper instrument calibration and adjustment. This appendix is intended to provide basic information.

Remember

A damaged connector can destroy any connector attached to it.

Basic connector care comprises three parts:

1. visual inspection
2. cleaning
3. mechanical inspection

Visual Inspection

Visually inspect all system connectors often. Examine connectors for problems such as contamination or corrosion, especially on the contacting surfaces. Look for deformed threads, burrs, scratches, rounded shoulders, and similar signs of wear or damage. Any visible problem can degrade performance; clean, reinspect, and, if necessary, replace the connector.

Cleaning

- Try compressed air first.

Use compressed air to loosen particles on the connector mating plane surfaces. Clean air cannot damage a connector, or leave particles or residues behind.

- If a solvent is necessary, use *only* isopropyl alcohol.

If there is dirt or contamination on a connector that you cannot removed with compressed air, try a foam swab or lint-free cleaning cloth moistened with isopropyl alcohol.

- Use the least amount of alcohol possible.
- Avoid getting any plastic parts in the connectors wet with the alcohol.
- Never spray alcohol directly into a connector.
- Check the alcohol periodically for contamination.

Mechanical Inspection

Because coaxial connector mechanical tolerances can be very precise (on the order of a few hundredths of microinches), even a perfectly clean, unused connector can cause trouble if it is mechanically out of specification. Use a connector gage to mechanically inspect coaxial connectors. Gage a connector at the following times:

- Before you use it for the first time.
- If either visual inspection or electrical performance indicates that the connector interface may be out of specification (due to wear or damage, for example).
- The device is used on another system or piece of equipment.
- As a matter of routine: initially after every 100 connections, and after that as often as experience suggests.

Index

- A**
 - AC detection, 1-2, 3-1
 - adjustments, 5-1
 - coarse zero adjustment, 5-1-2
 - feedthrough nulling adjustment, 5-1-2
 - autozero, 4-7

- B**
 - bridge
 - directivity, 4-2
 - source match, 4-2

- C**
 - cable
 - lead identification, 2-3
 - replacing, 7-3
 - cable assembly, 7-3
 - characterizing the detector, 3-7
 - characterizing the source, 4-7
 - cleaning connectors, A-1
 - coarse zero adjustment, 5-1
 - computing the maximum error, 4-8
 - worksheet, 4-9
 - connector
 - care, A-1
 - cleaning, A-1
 - mating, 2-3
 - mating a 3.5 mm to an SMA connector, 2-4
 - mechanical inspection, A-2
 - torque values, 3-2
 - visual inspection, A-1
 - contacting Agilent, 6-5
 - cover
 - attaching, 7-2
 - removing, 7-2

- D**
 - DC detection, 3-1
 - detector
 - characterization, 3-7
 - connecting, 2-3
 - power calibration, 3-7
 - replacing, 7-2
 - zeroing, 3-5
 - detector rebuild/exchange, 7-1
 - dynamic accuracy, 3-3
 - dynamic accuracy of the 8757D, 4-2
 - dynamic power accuracy, 4-10

- E** electrical performance, 4-1
 - electrostatic discharge (ESD), 2-2
 - cautions, 3-1
 - equipment, 4-6
 - exchange credit, 7-1

 - F** feedthrough nulling adjustment, 5-1
 - floor mat
 - use, 2-2
 - frequency response, 4-5
 - correction constants, 3-3
 - correction factors, 3-3

 - G** gaging, 2-4

 - H** heel strap
 - use, 2-2

 - I** initial inspection, 2-1
 - installation, 2-1

 - M** mat
 - use, 2-2
 - measurement errors
 - sources, 4-2
 - measurements
 - AC detection, 3-6
 - DC detection, 3-5
 - measurement system configuration, 3-4
 - measuring the detector, 4-7
 - measuring the source, 4-7
 - mixer or multiplier, when using
 - manually entering frequencies, 3-3
 - module exchange program, 6-4
-
- O** operating environment, 2-6
 - operation
 - theory, 3-1
 - ordering parts, 6-1
-
- P** packaging, 2-6
 - performance tests, 4-1
 - dynamic accuracy, 4-1-10
 - frequency response, 4-1, 4-5
 - return loss, 4-3
 - power
 - requirements, 2-3

- R**
 - reflection measurements, 1-2
 - removing covers, 7-2
 - repairable parts, 7-1
 - replaceable parts, 6-1
 - replacing
 - cable, 7-3
 - detector, 7-2
 - return loss, 4-3
 - test description, 4-2

- S**
 - safety considerations, 2-1
 - service, 7-1
 - returning detector for service, 2-7
 - setup
 - AC detection mode, 3-4-6
 - DC detection mode, 3-4-5
 - static-safe
 - practices, 2-2
 - workstation, 2-2
 - storage and shipment, 2-6
 - environment, 2-6

- T**
 - table mat
 - use, 2-2
 - test records, 4-13
 - transmission measurements, 1-2

- W**
 - W1 cable
 - replacement, 7-3
 - wrist strap
 - use, 2-2

- Z**
 - zeroing, 3-6
 - autozero, 3-6
 - manual zero, 3-6
 - repeat zero, 3-6

